

**Przeznaczenie:** sofa przeznaczona do wnętrz domowych, biurowych i przestrzeni publicznych

**Konstrukcja:** stelaż drewniany ze sklejki, płyty meblowej i elementów z litego drewna bukowego

**Oparcie:** stelaż drewniany ze sklejki, płyty meblowej i elementów z litego drewna bukowego, kombinacja pianek o różnych gęstościach; poduchy oparciowe dostępne w trzech wariantach:

– syntetycznym: rdzeń z pianki poliuretanowej, kulka silikonowa lub rdzeń i wypełnienie z pianki poliuretanowej

– naturalnym: rdzeń z pianki poliuretanowej, półpuch

**Siedzisko:** listwy sprężynujące, kombinacja pianek o różnych gęstościach

**Podstawa:** dostępne są dwie wersje podstaw:

– dwupunktowa w kształcie litery V: wykonana z laserowo ciętego i spawanego kątownika stalowego

– ptoza: wykonana z laserowo ciętej i spawanej blachy

– podstawa dostępna w kolorach standardowych z palety RAL, w lakierach strukturalnych Sahara oraz w kolorach miedź, rdza i perłowy mosiądz;

– dostępne stopki dla podłogi miękkiej oraz twardej. Prosimy o zaznaczenie w zamówieniu wybranych stopek.

**Stoliki:** płyta meblowa fornirowana okleiną naturalną z dębu, lakierowana w kolorystyce w kolekcji fornirow Comforty

## **DOSTĘPNE AKCESORIA DODATKOWE:**

Poduszki:

– poducha lędźwiowa: wypełnienie naturalne (półpuch) lub syntetyczne (kulka silikonowa)

– poduszka sypcząca: wypełnienie naturalne (półpuch) lub syntetyczne (kulka silikonowa)

– poduszka kopertówka: wypełnienie naturalne (półpuch) lub syntetyczne (kulka silikonowa)

Porty ładujące urządzenia mobilne:

Ładowarka indukcyjna (montowana do blatu w stolikach)

## **INFORMACJE DODATKOWE:**

Dostępne są trzy rodzaje wypełnień poduch oparciowych

– pianka: wygląd zgeometryzowany, z wyrażeniem zarysowanymi krawędziami – polecany do wnętrz biurowych

– pianka + kulka silikonowa: wypełnienie zalecane osobom alergicznym – wygląd udomowiony

– pianka + półpuch: wygląd udomowiony, luksusowy charakter wypełnienia z puchu – poduchy takie należy regularnie przetrząsać celem powrotu do pierwotnego wyglądu i zapobiegania trwałemu zniekształceniu poduchy

Zużycie tkaniny powierzonej znajdziesz w końcowej części cennika.

## **Dodatkowe opcje**



## **Dostępne rodzaje wykończeń (ceny nie podlegają rabatom):**

### **Podstawa wykończenie**

Stal półmat, lakierowana proszkowo, standardowo 20 kolorów z próbnika RAL

Stal półmat, lakierowana proszkowo: miedź, perłowy mosiądz, rdza

Stal lakierowana proszkowo, wykończenie w strukturze piasku: Sahara Night 520, Sahara Black 501, Sahara Grey 502, Sahara Blue 504, Sahara Silver 507, Sahara Mirage 509, Sahara Shade 522, Sahara Biały

### **Stoliki wykończenie**

dąb naturalny

orzech amerykański

### **Dopłata do łączenia modułów**

Dopłata do łączenia modułów

### **Nogi**

Nogi stalowe B (płoz) niskie (kpl)

Nogi stalowe B (płoz) niskie (kpl) - rozmiar 240, 256, 272

Nogi stalowe C (dwupunktowa w kształcie litery V) niskie (kpl)

Nogi stalowe C (dwupunktowa w kształcie litery V) niskie (kpl) - rozmiar 240, 256, 272



# Grid Bold design Jan Kochański, 2022

## Elementy składowe systemu Grid Bold:

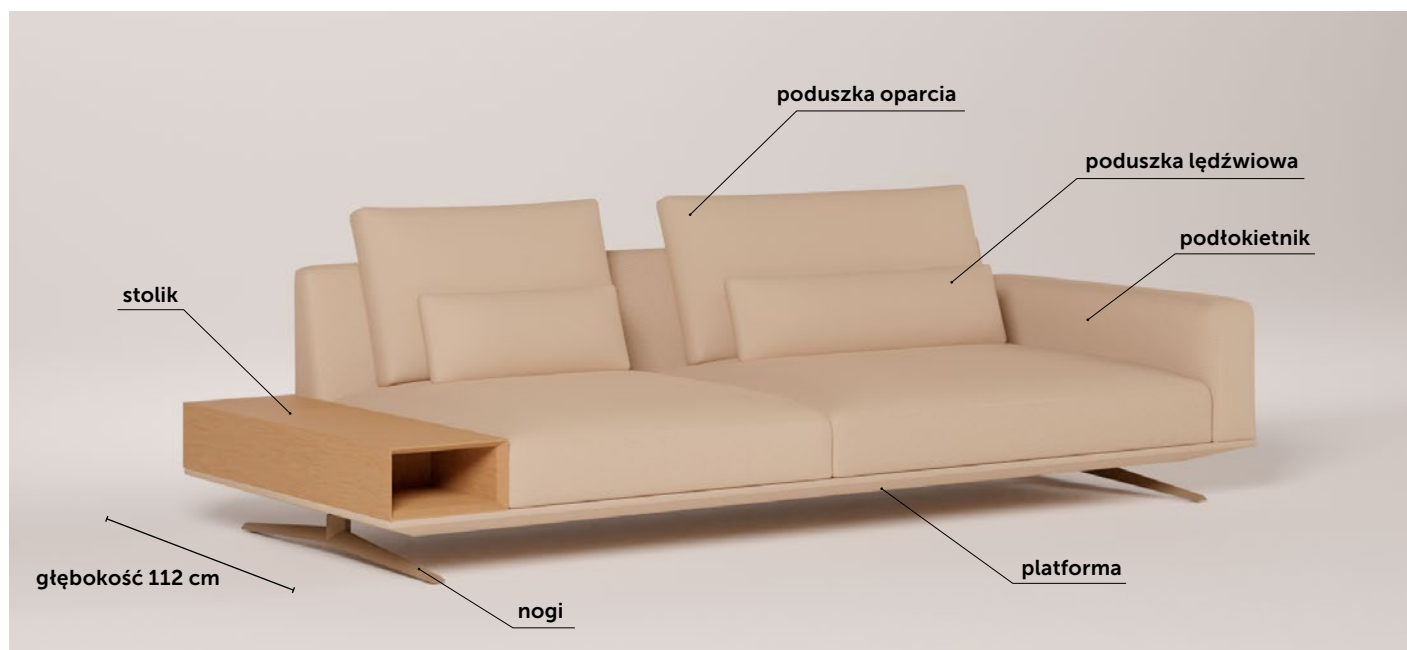

## Opcjonalne stoliki montowane na platformach



stolik mały  
szer. 32 cm

stolik średni  
szer. 48 cm

stolik duży  
szer. 112 cm

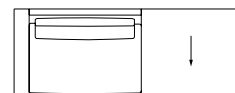

Stoje na wszystkich stolikach biegną w poprzek modułów, na których się znajdują. Kierunek na ilustracjach wyznacza strzałka.

## Opcjonalny wbudowany indukcyjny port ładujący urządzenia mobilne: montowany na środku stolika



Comforty przedstawia w swojej ofercie podstawową listę towarów, jednocześnie zastrzega sobie prawo do czasowego ograniczenia dostępności lub wycofania poszczególnych produktów z oferty bez podania przyczyny, zmiany cen lub dodania nowych produktów i zmiany parametrów technicznych towarów już zamieszczonych w ofercie. Podane wymiary mogą różnić się o +/- 1 cm w zależności od wykończenia. Cennik nie stanowi oferty handlowej w rozumieniu art. 66 § 1 Kodeksu Cywilnego. Ceny towarów znajdujących się w ofercie są podane w złotych polskich i zawierają podatek VAT. EXW - Nowe Skalmierzyce, Polska/Poland

# Grid Bold *design Jan Kochański, 2022*

## Dostępne dwa rodzaje nóg dla Grid Bold:

Noga dwupunktowa w kształcie litery V:

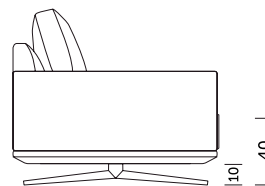

Noga płoza

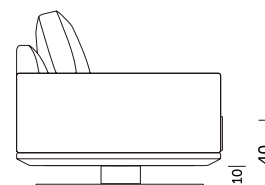

## Dostępne dwie szerokości podłokietników dla Grid Bold:

Podłokietnik 16 cm



Podłokietnik 32 cm



Comforty przedstawia w swojej ofercie podstawową listę towarów, jednocześnie zastrzega sobie prawo do czasowego ograniczenia dostępności lub wycofania poszczególnych produktów z oferty bez podania przyczyny, zmiany cen lub dodania nowych produktów i zmiany parametrów technicznych towarów już zamieszczonych w ofercie. Podane wymiary mogą różnić się o +/- 1 cm w zależności od wykończenia. Cennik nie stanowi oferty handlowej w rozumieniu art. 66 § 1 Kodeksu Cywilnego. Ceny towarów znajdujących się w ofercie są podane w złotych polskich i zawierają podatek VAT. EXW - Nowe Skalmierzyce, Polska/Poland

## Dostępne opcjonalne poduszki dla Grid Bold:

### Poduszki Łędźwiowe

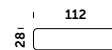
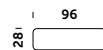

### Poduszki Sptycające Siedzisko



### Poduszki Kopertówki

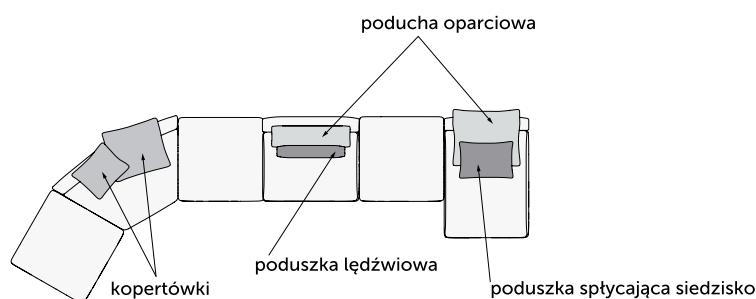

## Dodatkowe poduchy oparciowe i luźne poduszki

### Cena

Poduszka lędźwiowa 112 x 24 cm wypełnienie syntetyczne

Poduszka lędźwiowa 48 x 24 cm wypełnienie syntetyczne

Poduszka lędźwiowa 64 x 24 cm wypełnienie syntetyczne

Poduszka lędźwiowa 80 x 24 cm wypełnienie syntetyczne

Poduszka lędźwiowa 96 x 24 cm wypełnienie syntetyczne

Poduszka lędźwiowa 112 x 24 cm wypełnienie naturalne

Poduszka lędźwiowa 48 x 24 cm wypełnienie naturalne

Poduszka lędźwiowa 64 x 24 cm wypełnienie naturalne

Poduszka lędźwiowa 80 x 24 cm wypełnienie naturalne

Poduszka lędźwiowa 96 x 24 cm wypełnienie naturalne

Poduszka sptycająca 48 x 40 cm wypełnienie syntetyczne

Poduszka sptycająca 64 x 40 cm wypełnienie syntetyczne

Poduszka sptycająca 80 x 40 cm wypełnienie syntetyczne

Poduszka sptycająca 48 x 40 cm wypełnienie naturalne

Poduszka sptycająca 64 x 40 cm wypełnienie naturalne

Poduszka sptycająca 80 x 40 cm wypełnienie naturalne

Kopertówka 48 x 48 cm wypełnienie syntetyczne

Kopertówka 64 x 64 cm wypełnienie syntetyczne

Kopertówka 80 x 80 cm wypełnienie syntetyczne

Kopertówka 48 x 48 cm wypełnienie naturalne

Kopertówka 64 x 64 cm wypełnienie naturalne

Kopertówka 80 x 80 cm wypełnienie naturalne

## WYBRANE KONFIGURACJE GRID BOLD:

B\_01

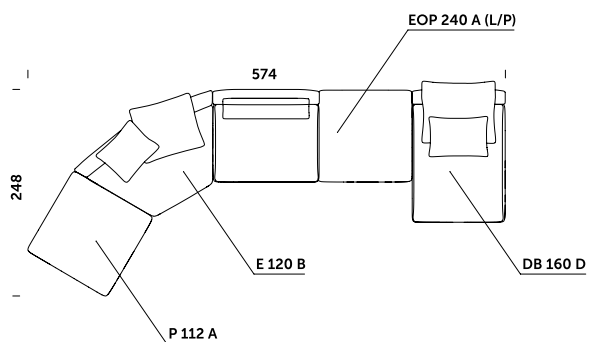

B\_02

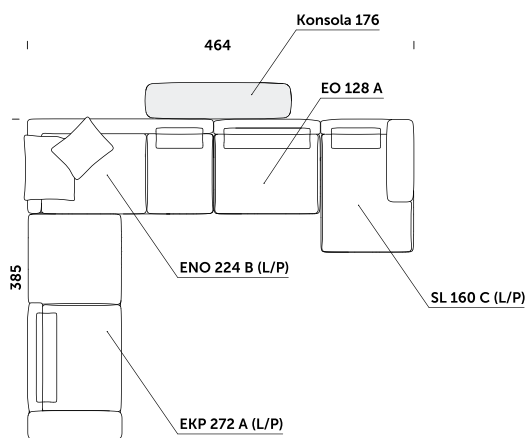

B\_03 A

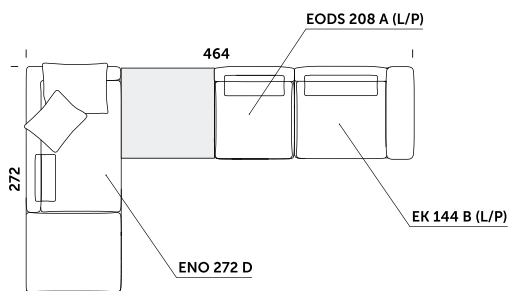

B\_03 B

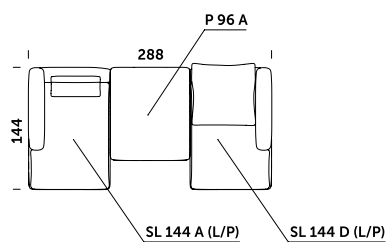

## B\_03 C

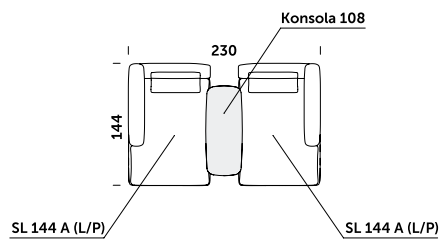

## B\_03 D

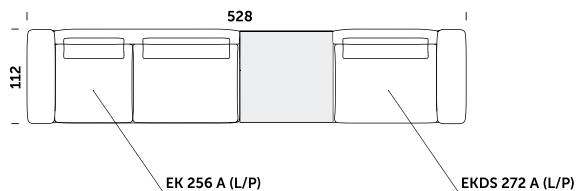

## B\_03 E

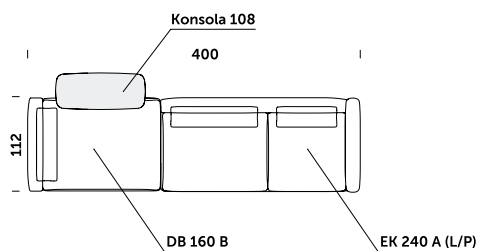

## B\_03 F

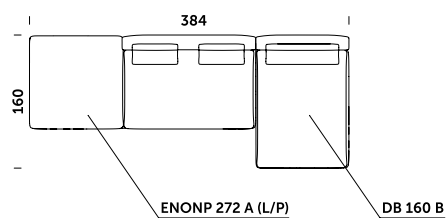

## B\_03 G

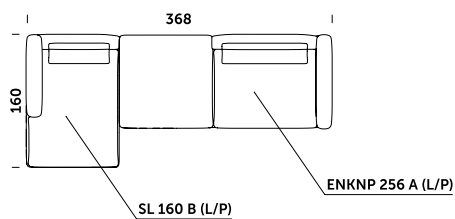

## B\_03 H

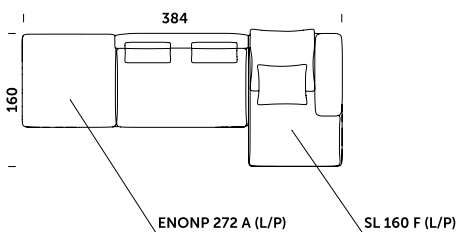

## B\_03 I

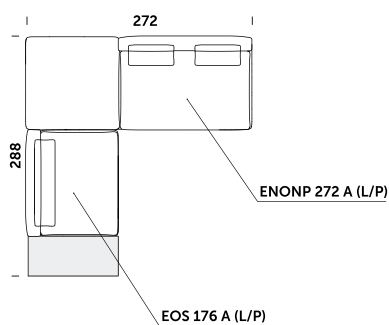

## B\_03 J

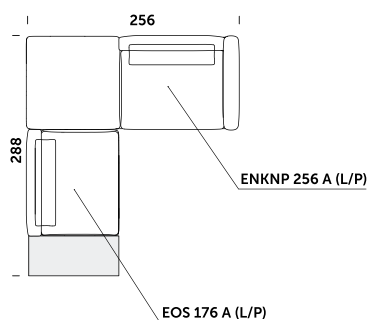

## B\_03 K

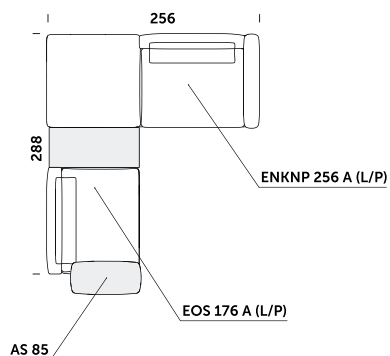

## B\_03 L

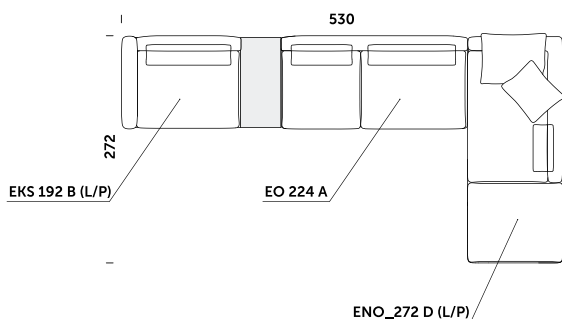

## B\_04

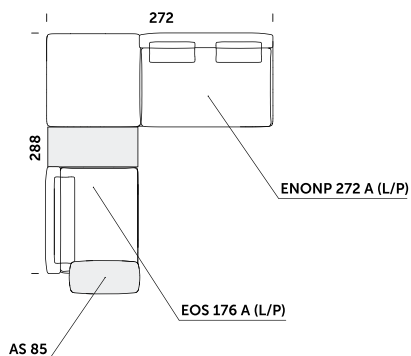

## B\_05

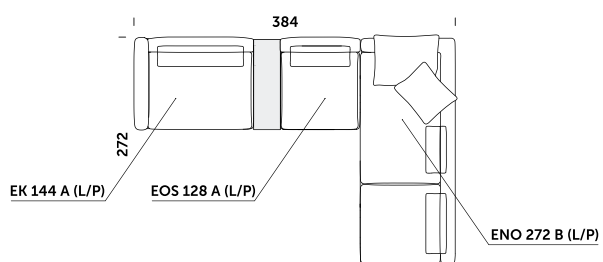

## B\_06

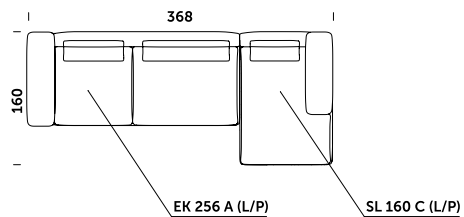

## B\_07

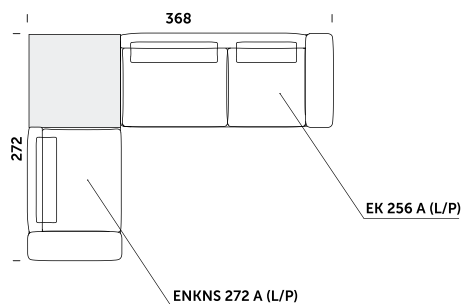

## B\_08 A

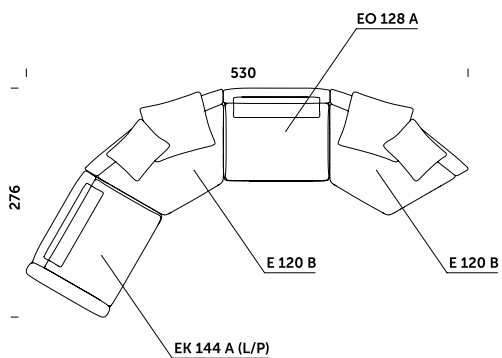

## B\_08 B

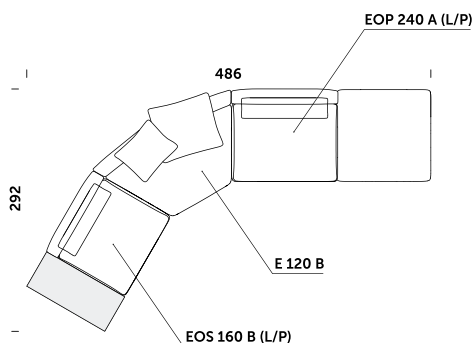

## B\_08 C

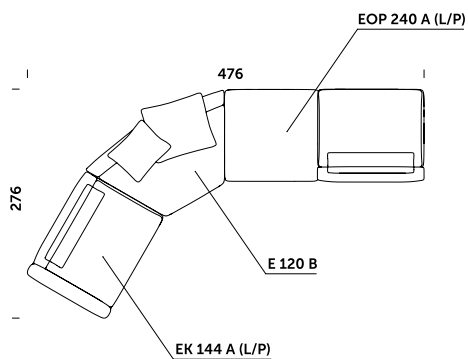

## B\_08 D

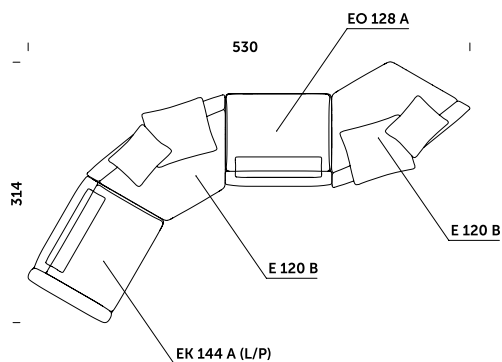

## B\_08 E

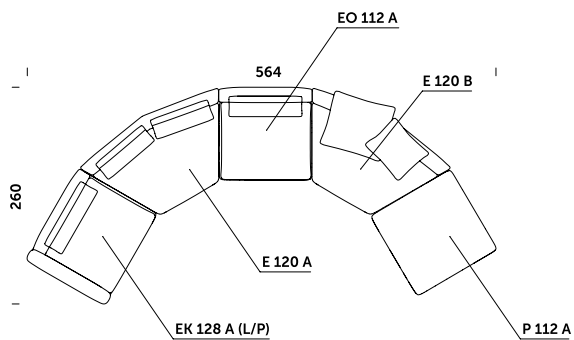

## B\_09

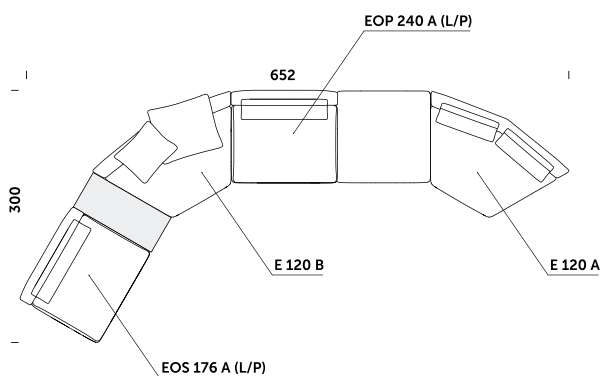

Comforty przedstawia w swojej ofercie podstawową listę towarów, jednocześnie zastrzega sobie prawo do czasowego ograniczenia dostępności lub wycofania poszczególnych produktów z oferty bez podania przyczyny, zmiany cen lub dodania nowych produktów i zmiany parametrów technicznych towarów już zamieszczonych w ofercie. Podane wymiary mogą różnić się o +/- 1 cm w zależności od wykończenia. Cennik nie stanowi oferty handlowej w rozumieniu art. 66 § 1 Kodeksu Cywilnego. Ceny towarów znajdujących się w ofercie są podane w złotych polskich i zawierają podatek VAT. EXW - Nowe Skalmierzyce, Polska/Poland

B\_10

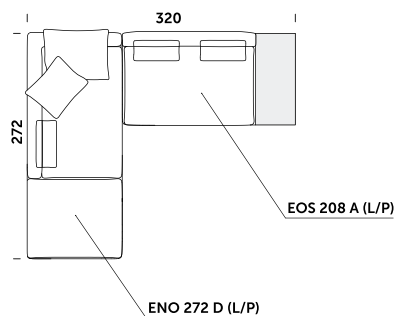

## Typoszereg nazw Grid Bold:

Sofy	S
Fotele Zamknięte	FZ
Fotele Zamknięte ze Stolikami L i P	FZS
Fotele Otwarte	FO
Fotele Otwarte ze Stolikami L i P	FOS
Elementy Kończące L i P	EK
Elementy Kończące ze Stolikami L i P	EKS
Elementy Kończące z Dużym Stolikiem L i P	EKDS
Elementy Kończące z Pufą L i P	EKP
Elementy Otwarte	EO
Elementy Otwarte ze Stolikami L i P	EOS
Elementy Otwarte z Dwoma Stolikami	EO2S
Elementy Otwarte z Dużym Stolikiem L i P	EODS
Elementy Otwarte z Pufą L i P	EOP
Elementy Narożne Otwarte L i P	ENO
Elementy Narożne Otwarte ze Stolikiem L i P	ENOS
Elementy Narożne Kończące L i P	ENK
Elementy Narożne Otwarte z Narożnym Stolikiem L i P	ENONS
Elementy Narożne Otwarte z Narożną Pufą L i P	ENONP
Elementy Narożne Kończące z Narożnym Stolikiem L i P	ENKNS
Elementy Narożne Kończące z Narożną Pufą L i P	ENKNP
Pufy	P
Day Beds	DB
Elementy 120°	E120
Szezlongi	SL

EKS\_128 A  
128x112x83cm

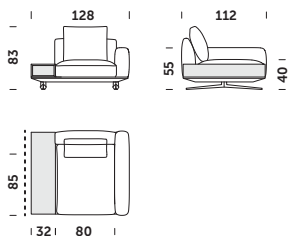

EKS\_144 A  
144x112x83cm

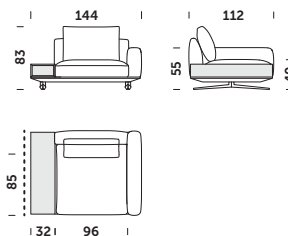

EKS\_144 B  
144x112x83cm

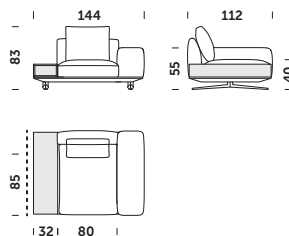

EKS\_144 C  
144x112x83cm

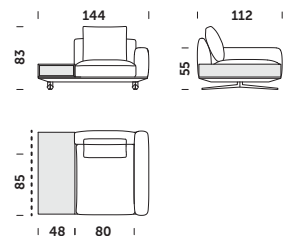

EKS\_160 A  
160x112x83cm

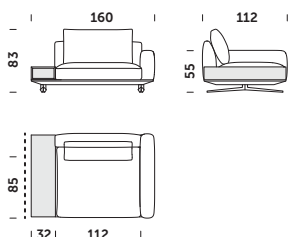

EKS\_160 B  
160x112x83cm

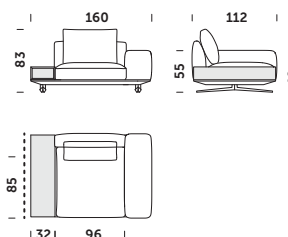

EKS\_160 C  
160x112x83cm

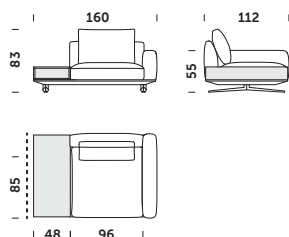

EKS\_160 D  
160x112x83cm

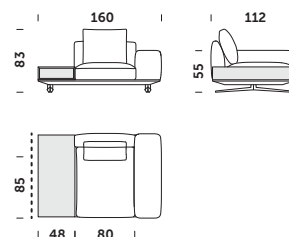

EKS\_176 A  
176x112x83cm

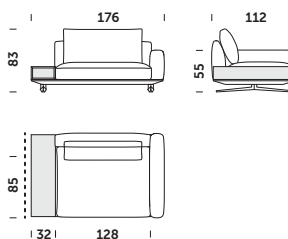

EKS\_176 B  
176x112x83cm

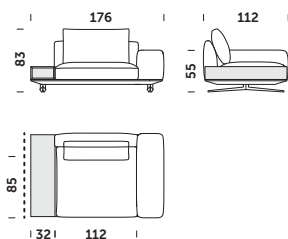

EKS\_176 C  
176x112x83cm

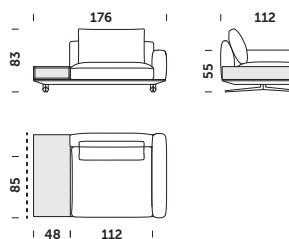

EKS\_176 D  
176x112x83cm

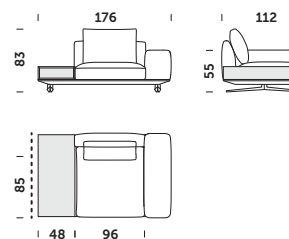

EKS\_192 A  
192x112x83cm

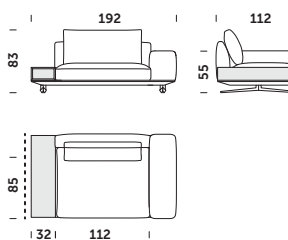

EKS\_192 B  
192x112x83cm

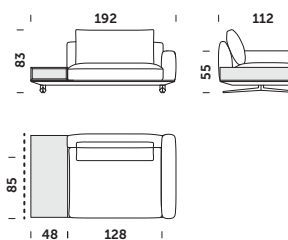

EKS\_192 C  
192x112x83cm

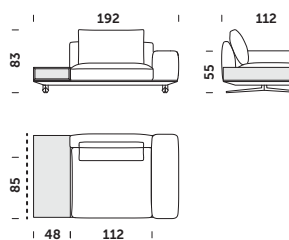

EKS\_208 A  
208x112x83cm

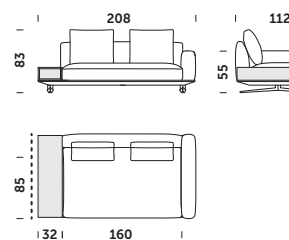

EKS\_208 B  
208x112x83cm

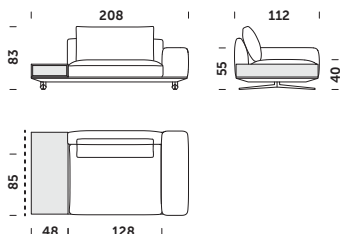

EKS\_224 A  
224x112x83cm

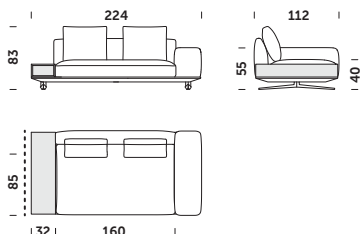

EKS\_224 B  
224x112x83cm

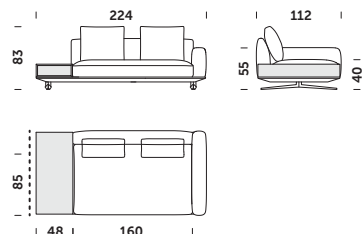

EKS\_240 A  
240x112x83cm

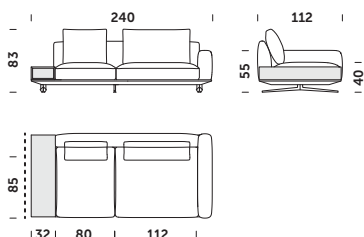

EKS\_240 B  
240x112x83cm

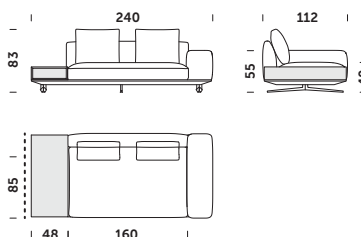

EKS\_256 A  
256x112x83cm

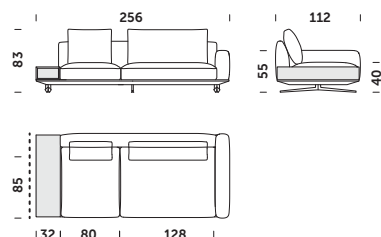

EKS\_256 B  
256x112x83cm

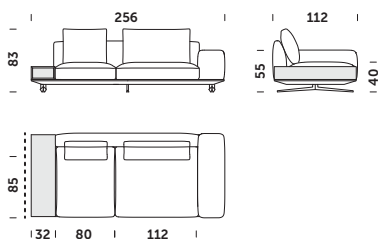

EKS\_256 C  
256x112x83cm

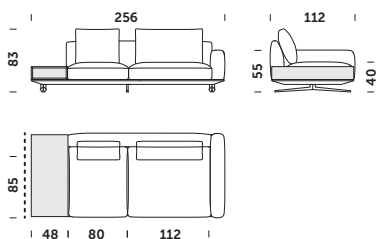

EKS\_272 A  
272x112x83cm

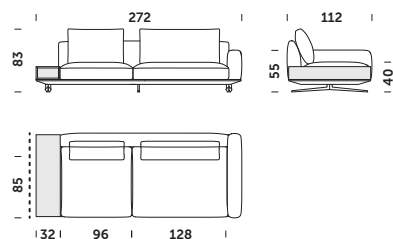

EKS\_272 B  
272x112x83cm

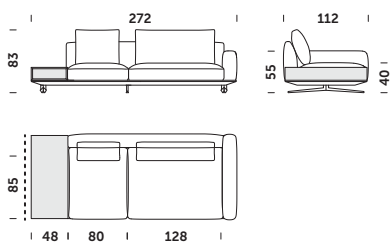

EKS\_272 C  
272x112x83cm

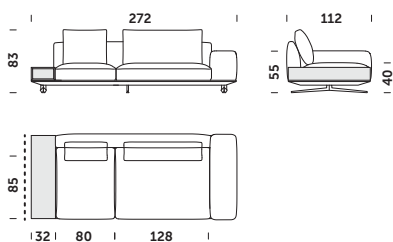

EKS\_272 D  
272x112x83cm

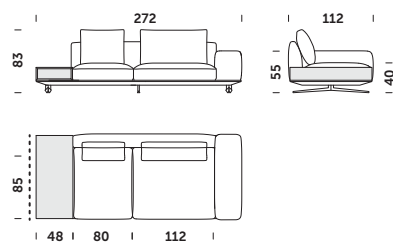

ENK\_160 A  
160x112x83cm

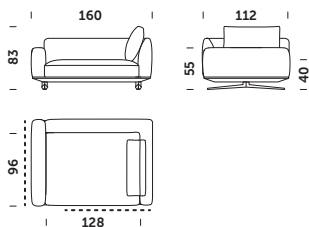

ENK\_160 B  
160x112x83cm

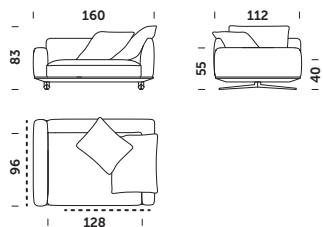

ENK\_176 A  
176x112x83cm

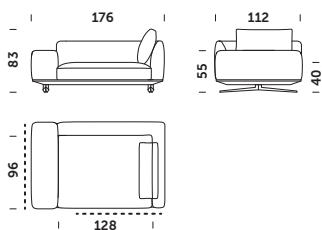

ENK\_176 B  
176x112x83cm

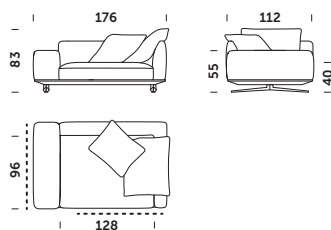

ENK\_192 A  
192x112x83cm

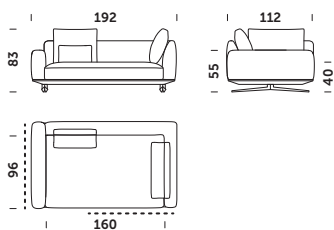

ENK\_192 B  
192x112x83cm

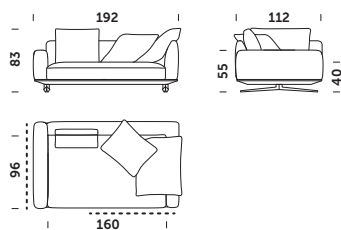

ENK\_208 A  
208x112x83cm

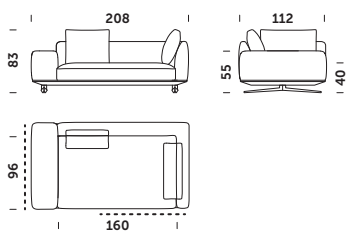

ENK\_208 B  
208x112x83cm

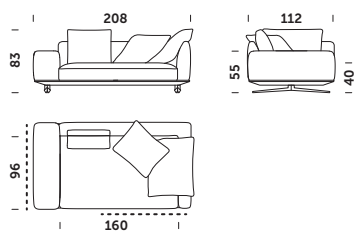

ENK\_240 A  
240x112x83cm

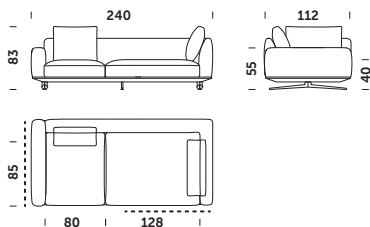

ENK\_240 B  
240x112x83cm

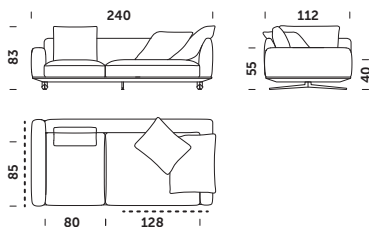

ENK\_256 A  
256x112x83cm

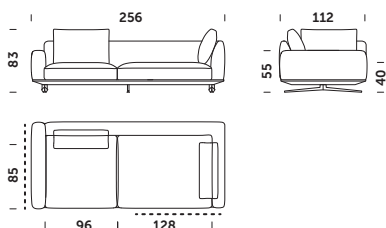

ENK\_256 B  
256x112x83cm

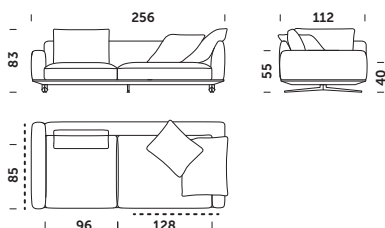

ENK\_256 C  
256x112x83cm

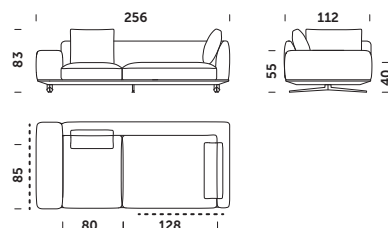

ENK\_256 D  
256x112x83cm

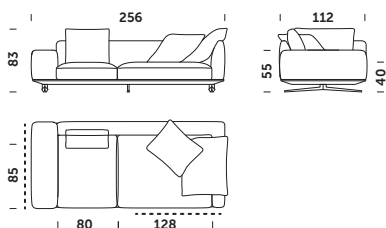

ENK\_272 A  
272x112x83cm

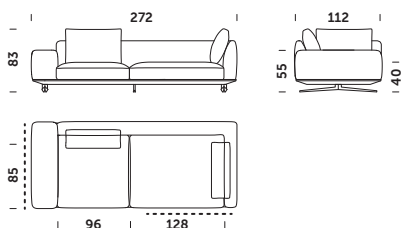

ENK\_272 B  
272x112x83cm

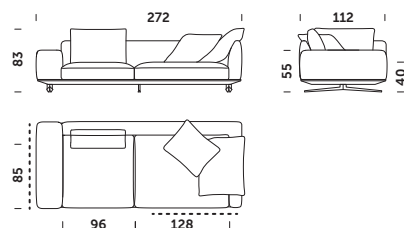

ENK\_272 C  
272x112x83cm

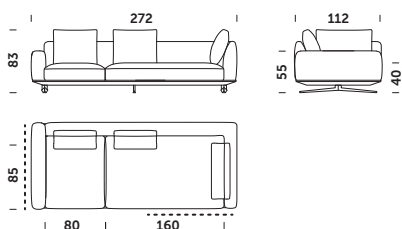

ENK\_272 D  
272x112x83cm

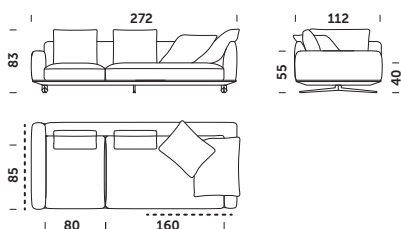

ENO\_144 A  
144x112x83cm

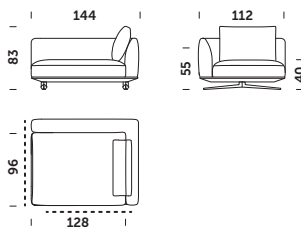

ENO\_144 B  
144x112x83cm

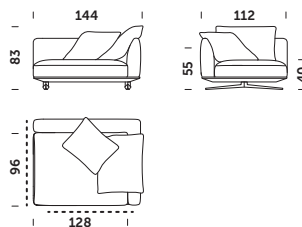

ENO\_176 A  
176x112x83cm

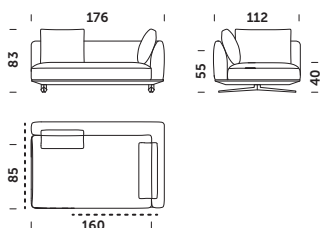

ENO\_176 B  
176x112x83cm

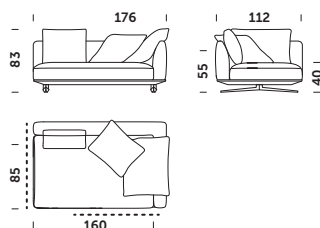

ENO\_224 A  
224x112x83cm

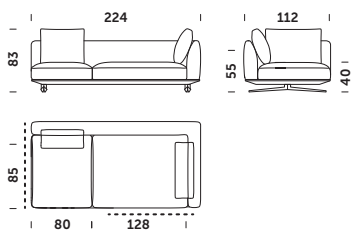

ENO\_224 B  
224x112x83cm

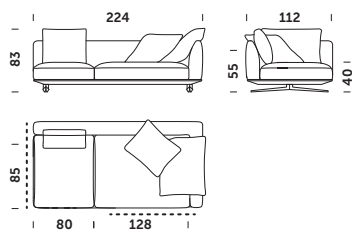

ENO\_224 C  
224x112x83cm

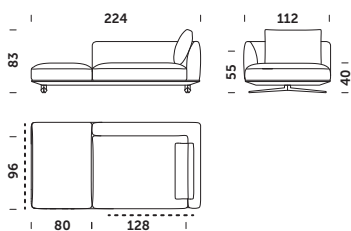

ENO\_224 D  
224x112x83cm

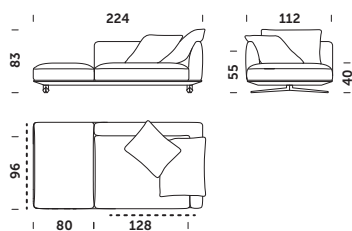

ENO\_240 A  
240x112x83cm

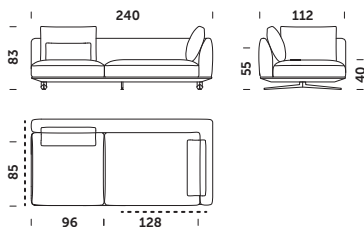

ENO\_240 B  
240x112x83cm

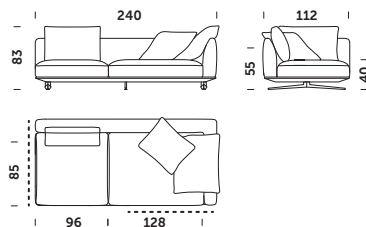

ENO\_240 C  
240x112x83cm

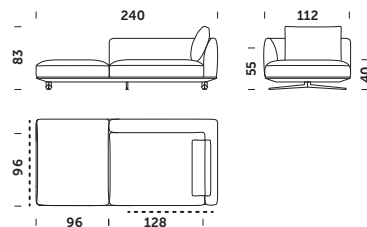

ENO\_240 D  
240x112x83cm

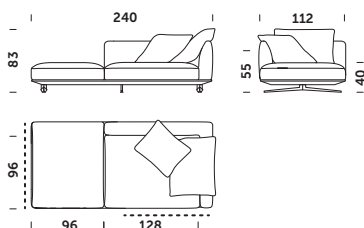

ENO\_256 A  
256x112x83cm

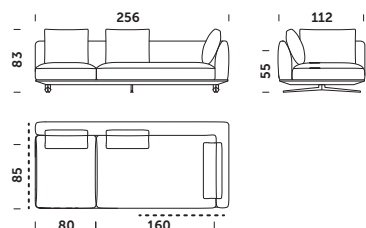

ENO\_256 B  
256x112x83cm

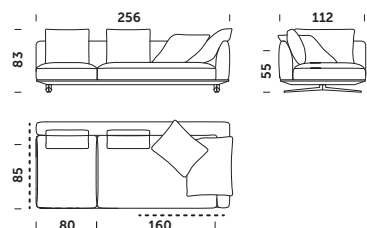

ENO\_256 C  
256x112x83cm

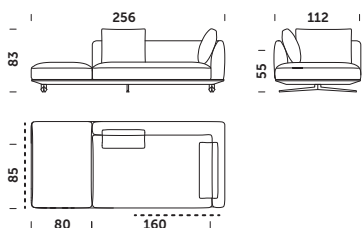

ENO\_256 D  
256x112x83cm

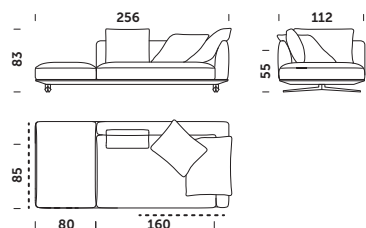

ENO\_256 E  
256x112x83cm

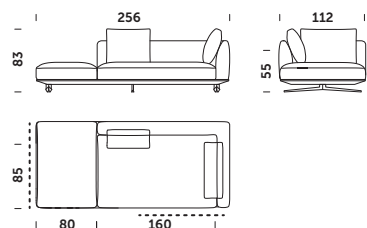

ENO\_256 F  
256x112x83cm

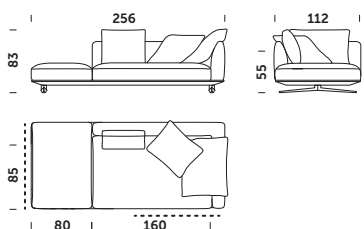

ENO\_256 G  
256x112x83cm

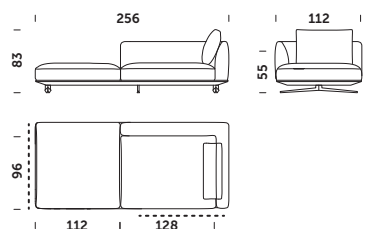

ENO\_256 H  
256x112x83cm

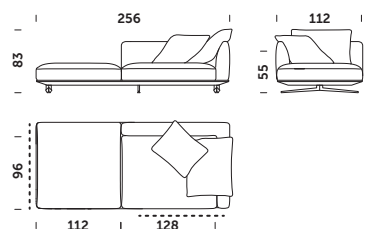

ENO\_272 A  
272x112x83cm

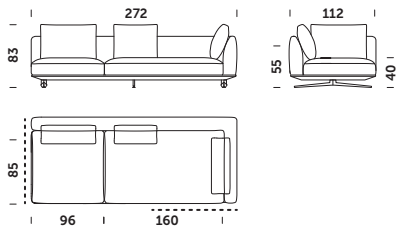

ENO\_272 B  
272x112x83cm

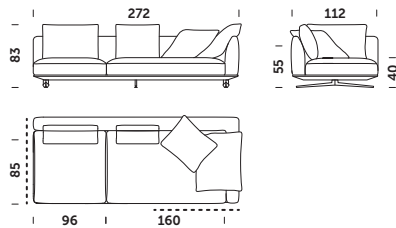

ENO\_272 C  
272x112x83cm

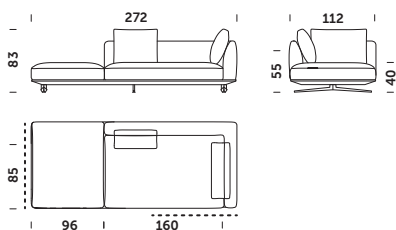

ENO\_272 D  
272x112x83cm

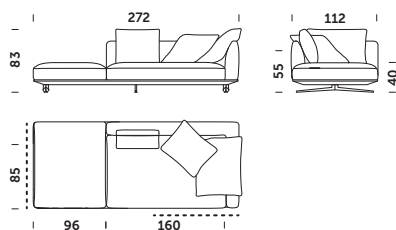

SL\_144 A  
99x144x83cm

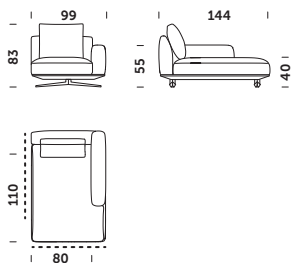

SL\_144 B  
112x144x83cm

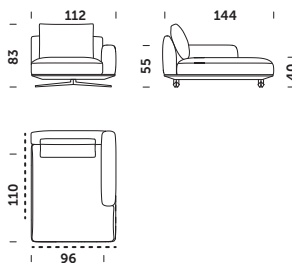

SL\_144 C  
112x144x80cm

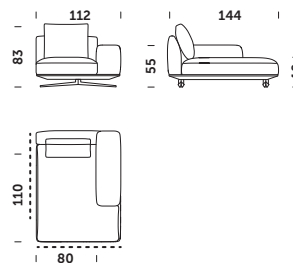

SL\_144 D  
99x144x75cm

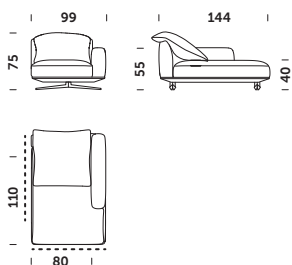

SL\_144 E  
112x144x75cm

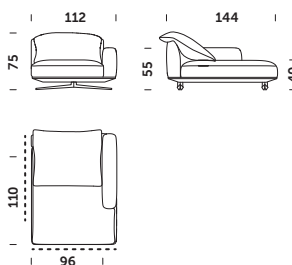

SL\_144 F  
112x144x75cm

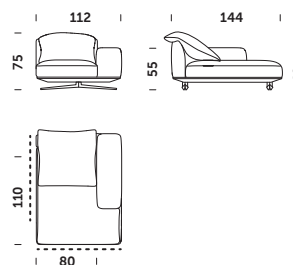

SL\_160 A  
99x160x83cm

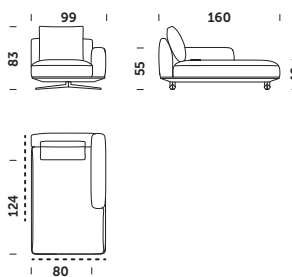

SL\_160 B  
112x160x83cm

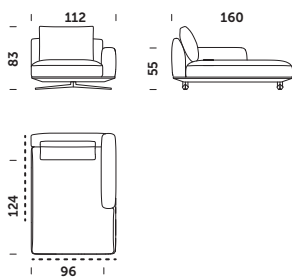

SL\_160 C  
112x160x80cm

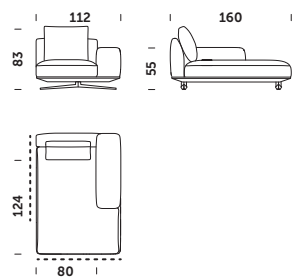

SL\_160 D  
99x160x75cm

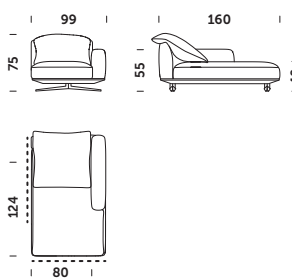

SL\_160 E  
112x160x75cm

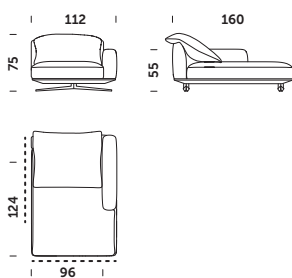

SL\_160 F  
112x160x75cm

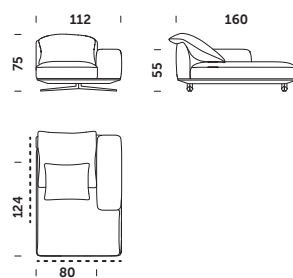

SL\_176 A  
99x176x83cm

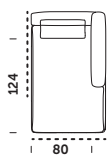
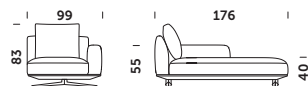

SL\_176 B  
112x176x83cm

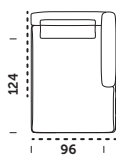
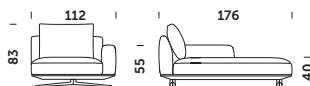

SL\_176 C  
112x176x83cm

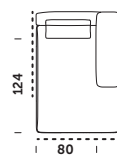
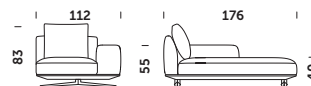

SL\_176 D  
99x176x83cm

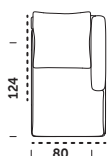

SL\_176 E  
112x176x83cm

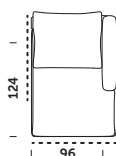
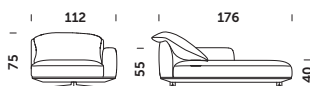

SL\_176 F  
112x176x83cm

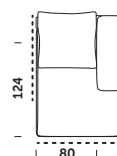
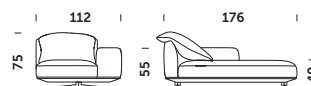

EKP\_208 A  
208x112x83cm

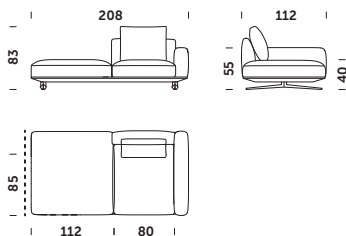

EKP\_224 A  
224x112x83cm

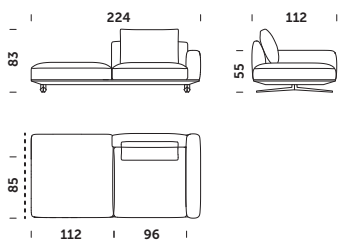

EKP\_224 B  
224x112x83cm

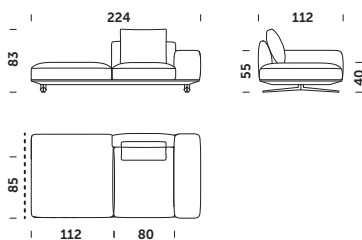

EKP\_240 A  
240x112x83cm

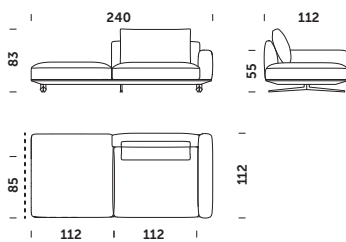

EKP\_240 B  
240x112x83cm

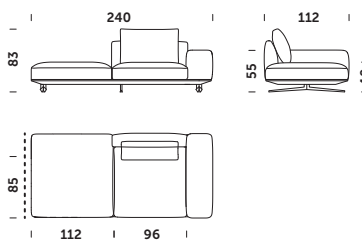

EKP\_256 A  
256x112x83cm

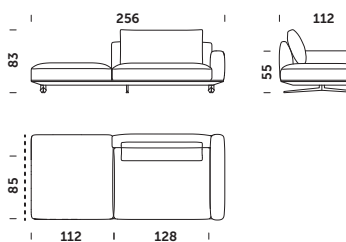

EKP\_256 B  
256x112x83cm

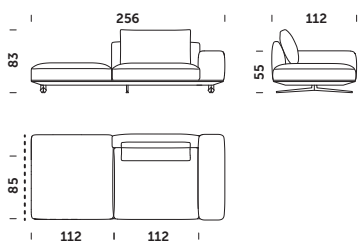

EKP\_272 A  
272x112x83cm

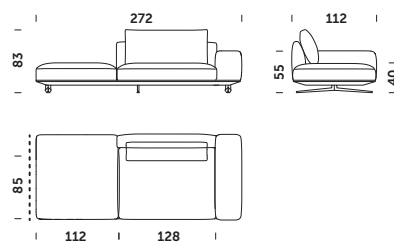

EKDS\_208 A  
208x112x80cm

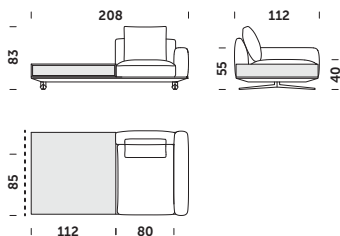

EKDS\_224 A  
224x112x80cm

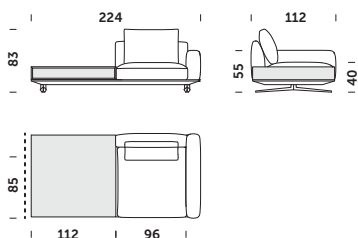

EKDS\_224 B  
224x112x80cm

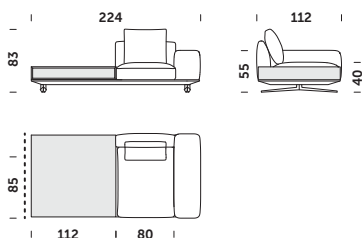

EKDS\_240 A  
240x112x80cm

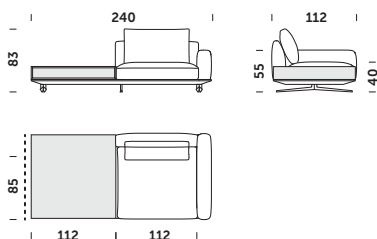

EKDS\_240 B  
240x112x80cm

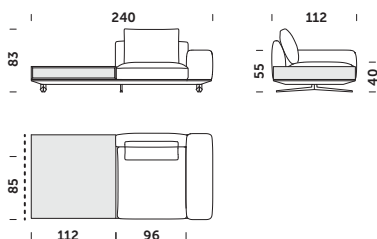

EKDS\_256 A  
256x112x80cm

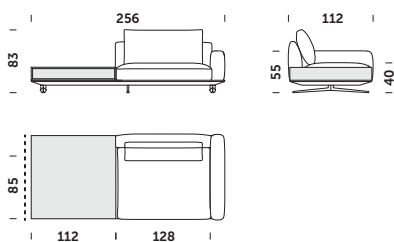

EKDS\_256 B  
256x112x80cm

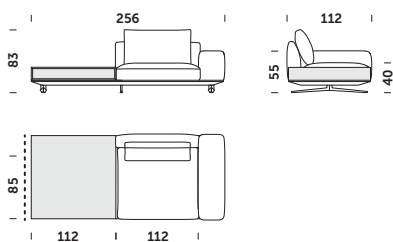

EKDS\_272 A  
272x112x80cm

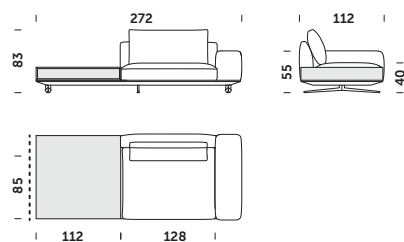

EO2S\_192 A  
192x112x83cm

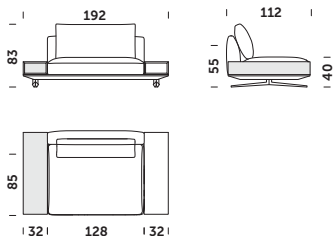

EO2S\_208 A  
208x112x83cm

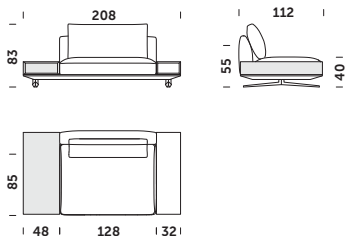

EO2S\_224 A  
224x112x83cm

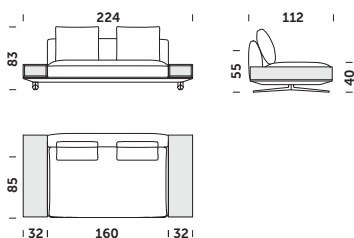

EO2S\_224 B  
224x112x83cm

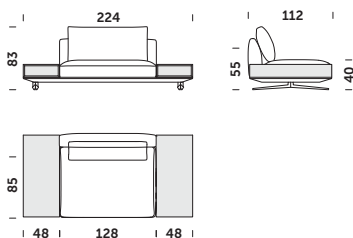

EO2S\_240 A  
240x112x83cm

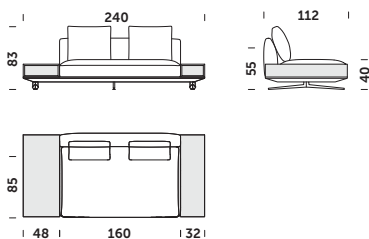

EO2S\_256 A  
256x112x83cm

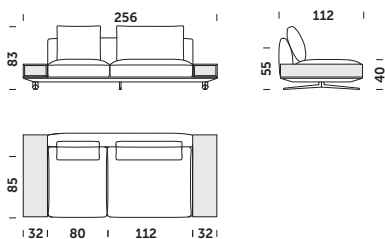

EO2S\_256 B  
256x112x83cm

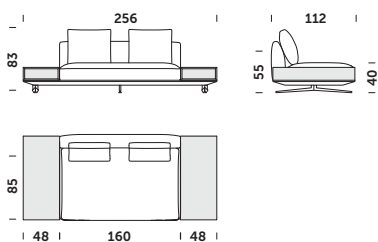

EO2S\_272 A  
272x112x83cm

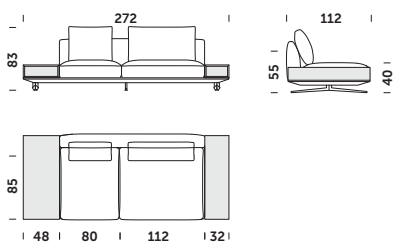

ENOS\_176 A  
176x112x83cm

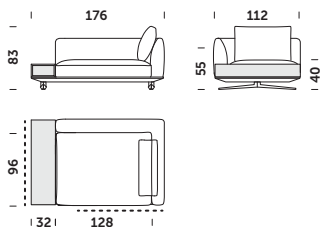

ENOS\_176 B  
176x112x83cm

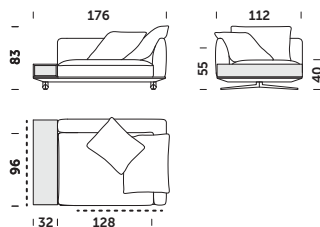

ENOS\_192 A  
192x112x83cm

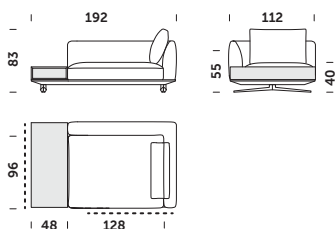

ENOS\_192 B  
192x112x83cm

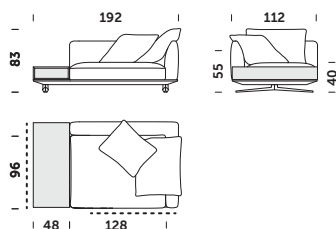

ENOS\_208 A  
208x112x83cm

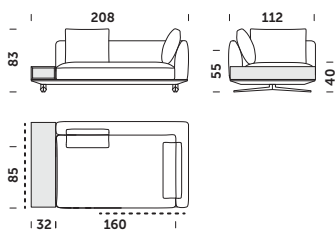

ENOS\_208 B  
208x112x83cm

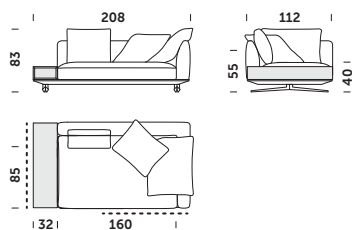

ENOS\_224 A  
224x112x83cm

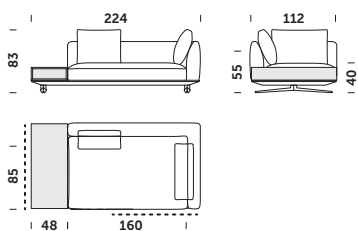

ENOS\_224 B  
224x112x83cm

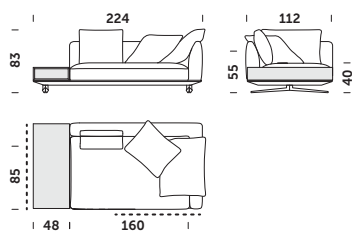

ENOS\_256 A  
256x112x83cm

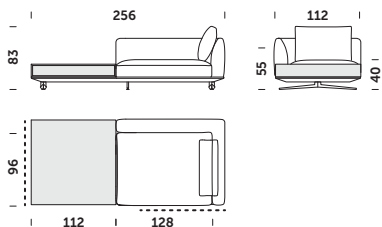

ENOS\_256 B  
256x112x83cm

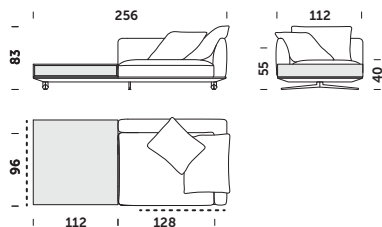

ENOS\_256 C  
256x112x83cm

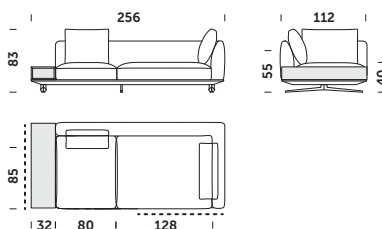

ENOS\_256 D  
256x112x83cm

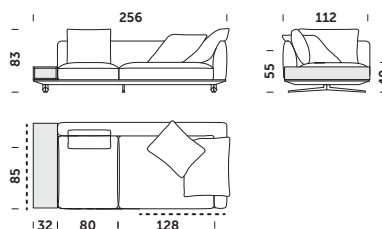

ENOS\_272 A  
272x112x83cm

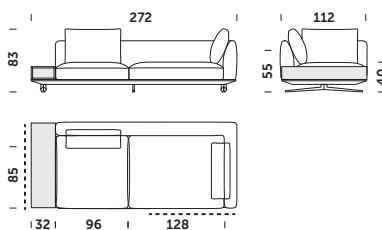

ENOS\_272 B  
272x112x83cm

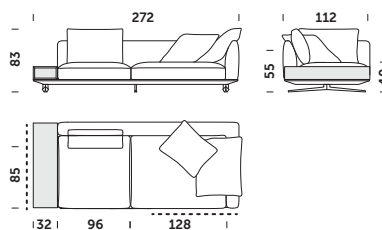

ENOS\_272 C  
272x112x83cm

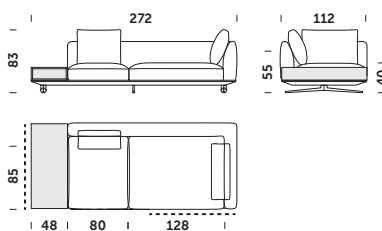

ENOS\_272 D  
272x112x83cm

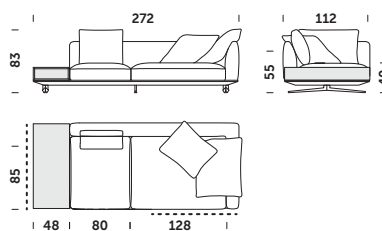

EK\_112 A  
112x112x83cm

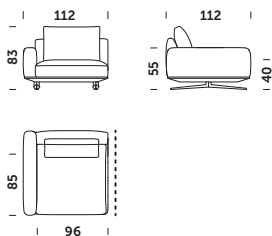

EK\_128 A  
128x112x83cm

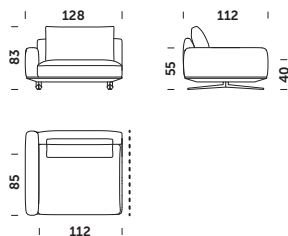

EK\_128 B  
128x112x83cm

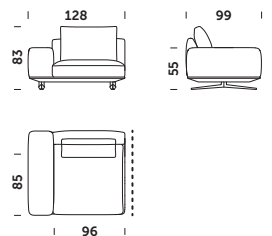

EK\_144 A  
144x112x83cm

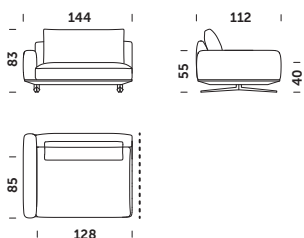

EK\_144 B  
144x112x83cm

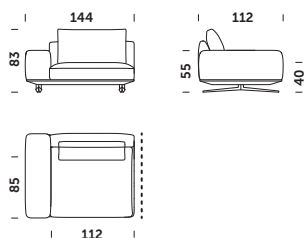

EK\_176 A  
176x112x83cm

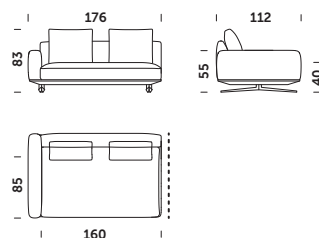

EK\_192 A  
192x112x83cm

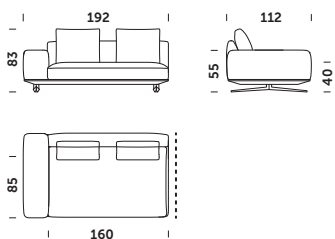

EK\_208 A  
208x112x83cm

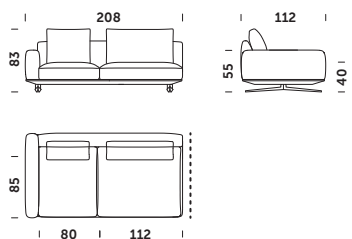

EK\_224 A  
224x112x83cm

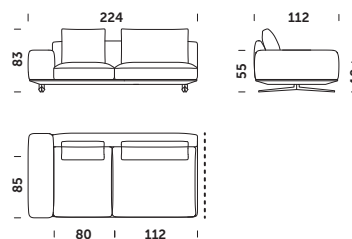

EK\_240 A  
240x112x83cm

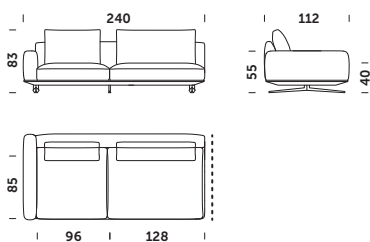

EK\_256 A  
256x112x83cm

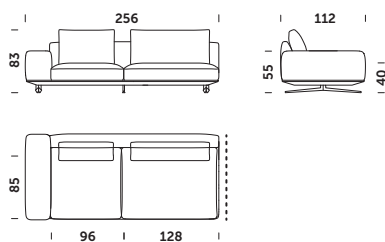

DB\_144 A  
99x144x83cm

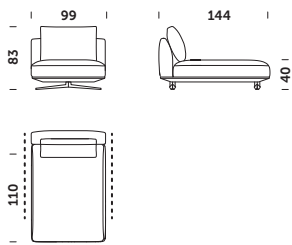

DB\_144 B  
112x144x83cm

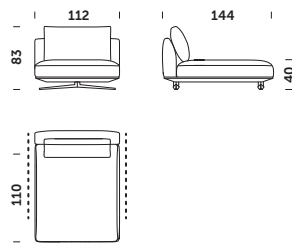

DB\_144 C  
99x144x76cm

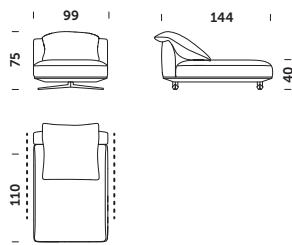

DB\_144 D  
112x144x76cm

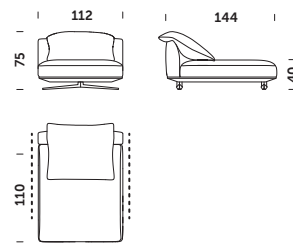

DB\_160 A  
99x160x83cm

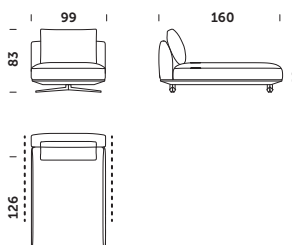

DB\_160 B  
112x160x83cm

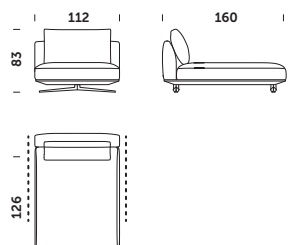

DB\_160 C  
99x160x76cm

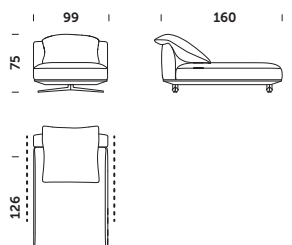

DB\_160 D  
112x160x76cm

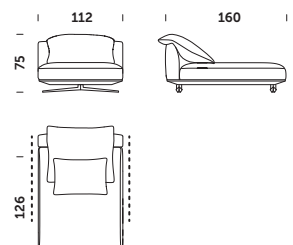

DB\_176 A  
99x176x83cm

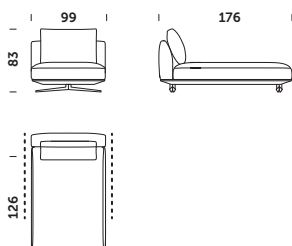

DB\_176 B  
112x176x83cm

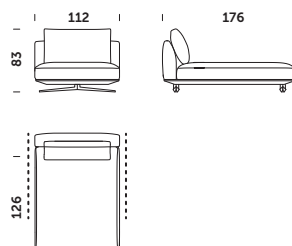

DB\_176 C  
99x176x83cm

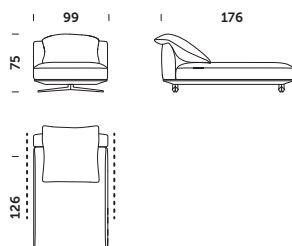

DB\_176 D  
112x176x83cm

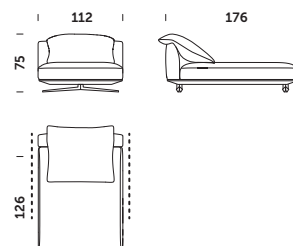

EO\_112 A  
112x112x83cm

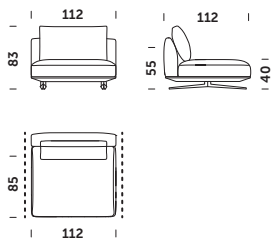

EO\_128 A  
128x112x83cm

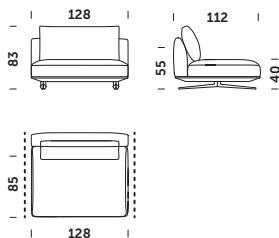

EO\_160 A  
160x112x83cm

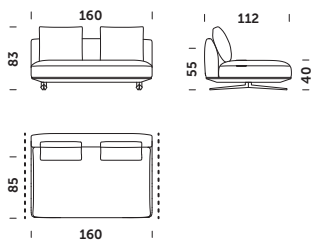

EO\_192 A  
192x112x83cm

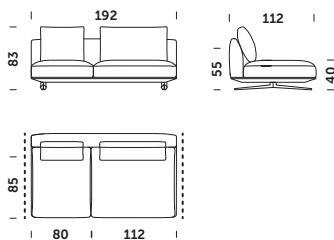

EO\_224 A  
224x112x83cm

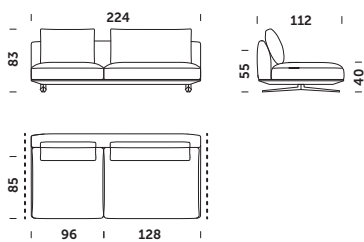

EO\_240 A  
272x112x83cm

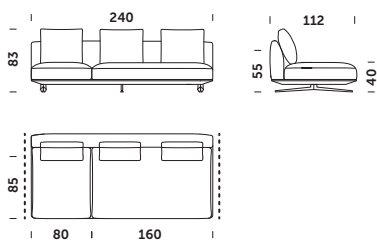

FO\_96 A  
96x112x83cm

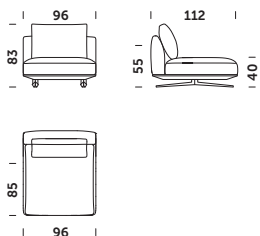

FO\_112 A  
112x112x83cm

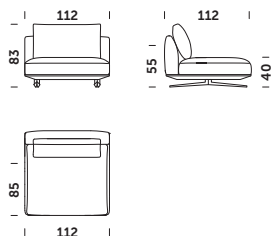

FOS\_112 A  
112x112x83cm

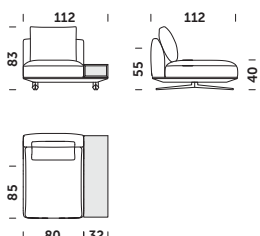

FOS\_128 A  
128x112x83cm

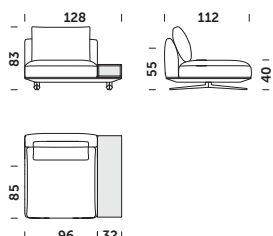

FOS\_128 B  
128x112x83cm

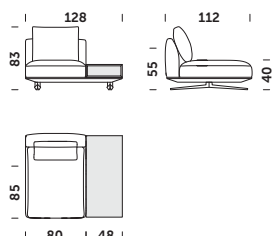

FOS\_144 A  
144x112x83cm

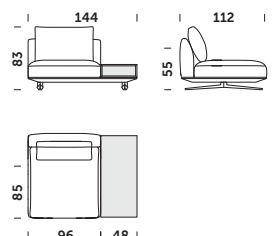

FZ\_112 A  
112x112x83cm

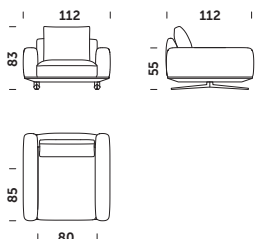

FZ\_128 A  
128x112x83cm

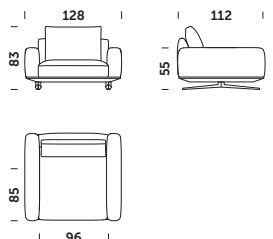

FZS\_128 A  
128x112x83cm

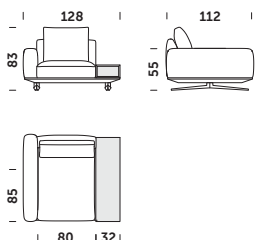

FZS\_144 A  
144x112x83cm

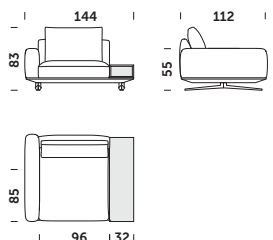

FZS\_144 B  
144x112x83cm

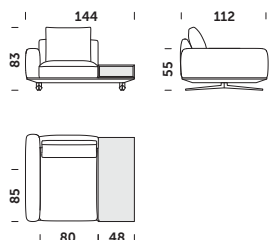

FZS\_160 A  
160x112x83cm

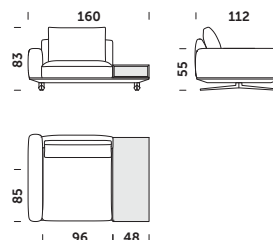

# Grid BOLD *design Jan Kochański, 2022*

---

E\_120 A  
208x112x83cm

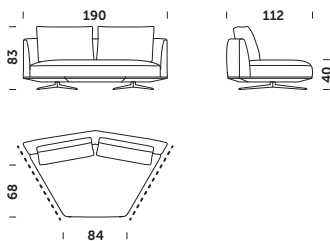

E\_120 B  
208x112x83cm

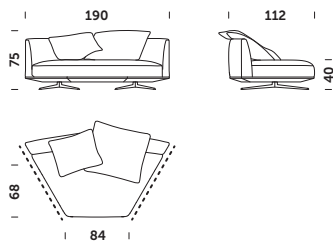

ENKNS\_208 A  
208x112x83cm

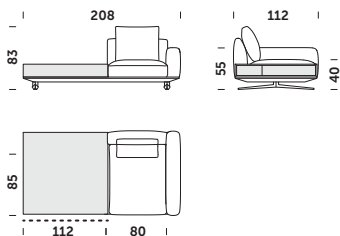

ENKNS\_224 A  
224x112x83cm

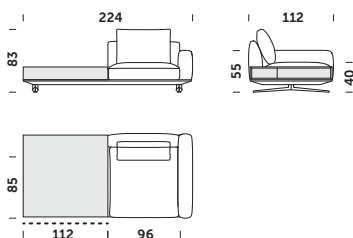

ENKNS\_224 B  
224x112x83cm

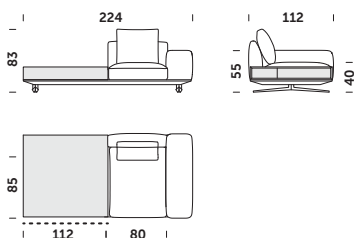

ENKNS\_240 A  
240x112x83cm

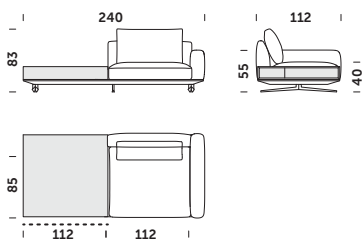

ENKNS\_240 B  
240x112x83cm

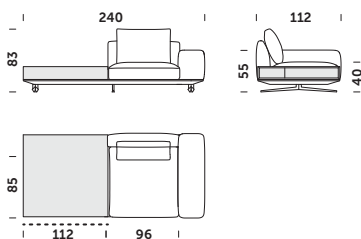

ENKNS\_256 A  
256x112x83cm

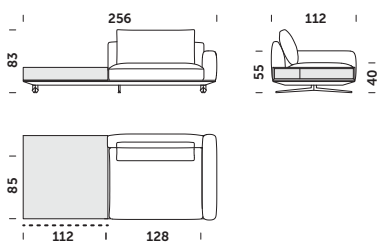

ENKNS\_256 B  
256x112x83cm

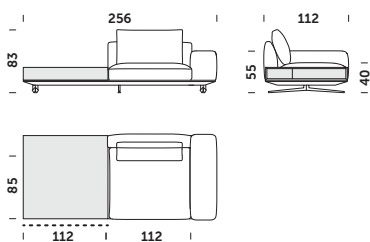

ENKNS\_272 A  
272x112x83cm

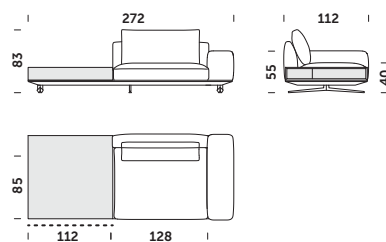

ENKNP\_208 A  
208x112x83cm

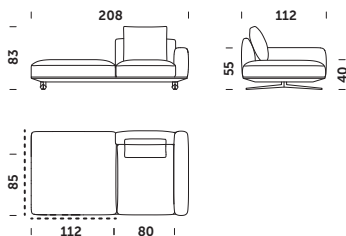

ENKNP\_224 A  
224x112x83cm

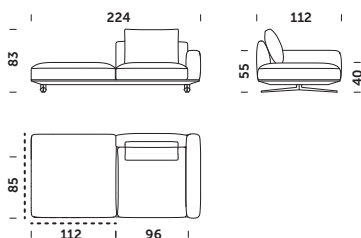

ENKNP\_224 B  
224x112x83cm

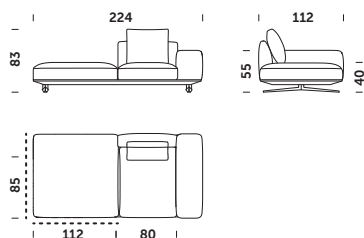

ENKNP\_240 A  
240x112x83cm

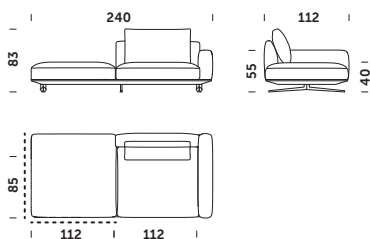

ENKNP\_240 B  
240x112x83cm

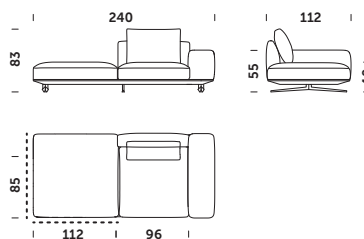

ENKNP\_256 A  
256x112x83cm

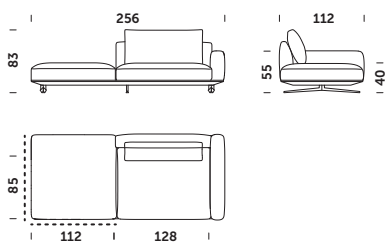

ENKNP\_256 B  
256x112x83cm

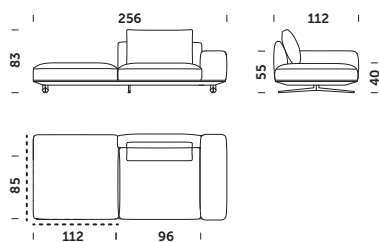

ENKNP\_272 A  
272x112x83cm

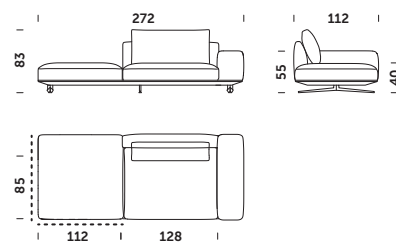

# Grid BOLD *design Jan Kochański, 2022*

ENONS\_192 A  
192x112x83cm

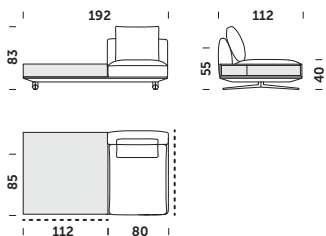

ENONS\_208 A  
208x112x83cm

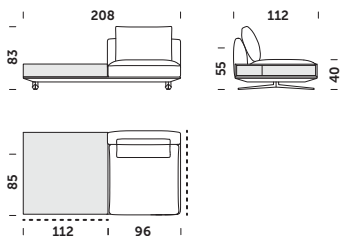

ENONS\_224 A  
224x112x83cm

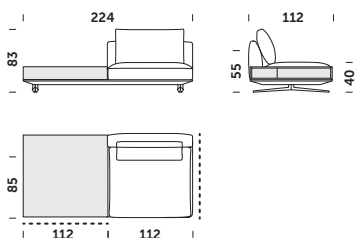

ENONS\_240 A  
240x112x83cm

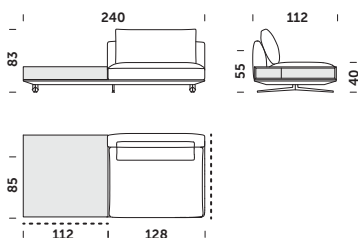

ENONS\_272 A  
272x112x83cm

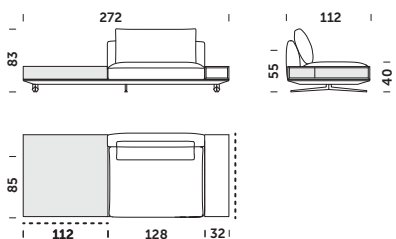

ENONS\_272 B  
272x112x83cm

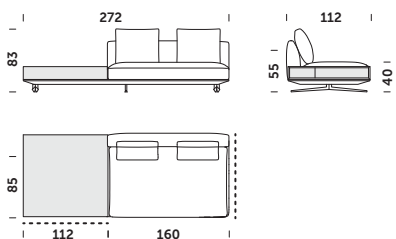

ENONP\_192 A  
192x112x83cm

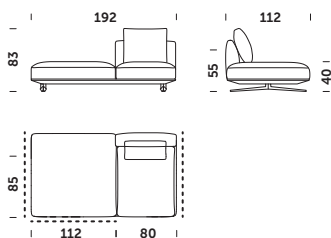

ENONP\_208 A  
208x112x83cm

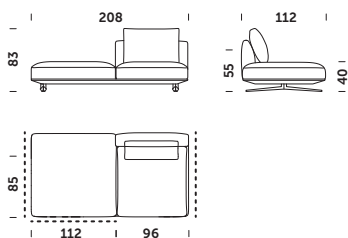

ENONP\_224 A  
224x112x83cm

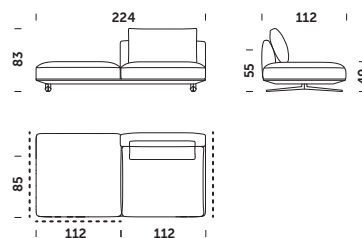

ENONP\_224 B  
224x112x83cm

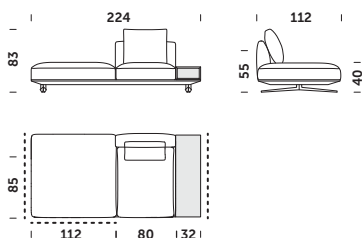

ENONP\_240 A  
240x112x83cm

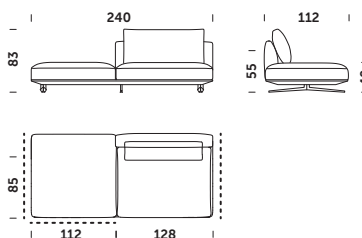

ENONP\_240 B  
240x112x83cm

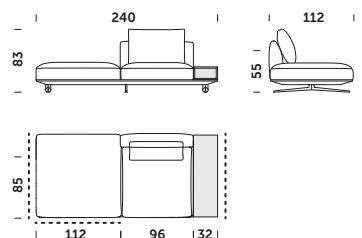

ENONP\_240 C  
240x112x83cm

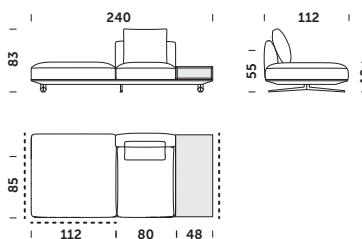

ENONP\_256 A  
256x112x83cm

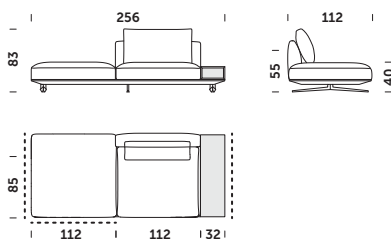

ENONP\_256 B  
256x112x83cm

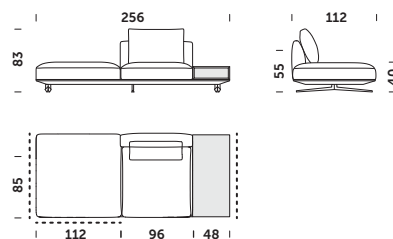

ENONP\_272 A  
272x112x83cm

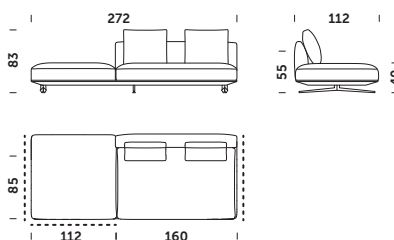

ENONP\_272 B  
272x112x83cm

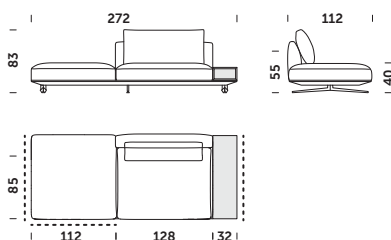

ENONP\_272 C  
272x112x83cm

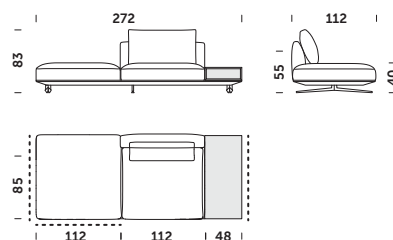

EODS\_192 A  
192x112x83cm

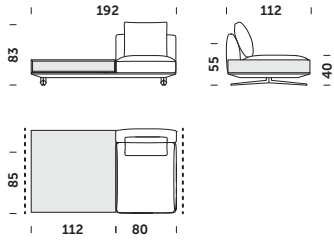

EODS\_208 A  
208x112x83cm

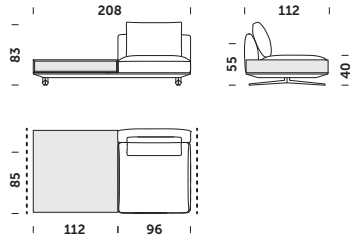

EODS\_224 A  
224x112x83cm

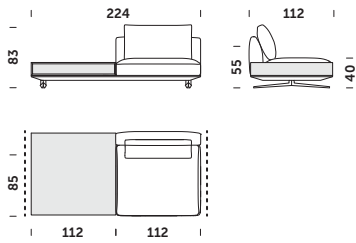

EODS\_240 A  
240x112x83cm

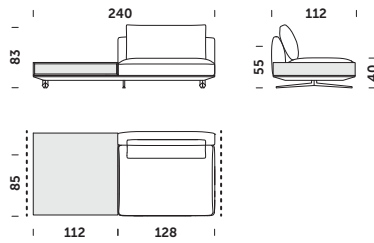

EODS\_272 A  
272x112x83cm

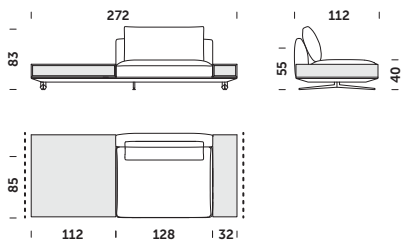

EOP\_192 A  
192x112x83cm

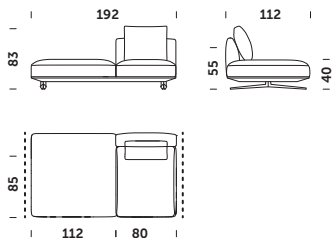

EOP\_208 A  
208x112x83cm

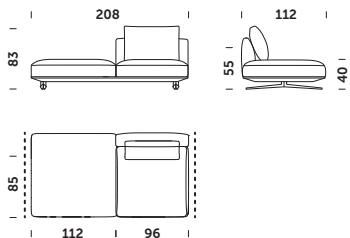

EOP\_224 A  
224x112x83cm

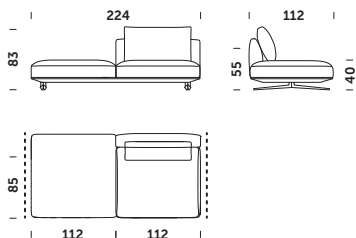

EOP\_224 B  
224x112x83cm

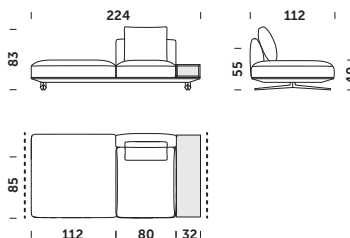

EOP\_240 A  
240x112x83cm

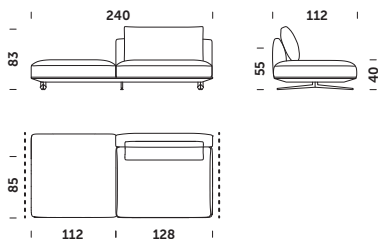

EOP\_240 B  
240x112x83cm

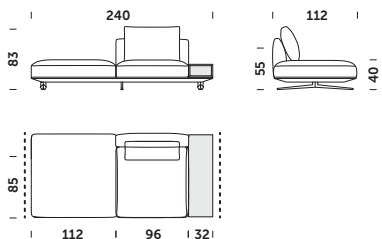

EOP\_240 C  
240x112x83cm

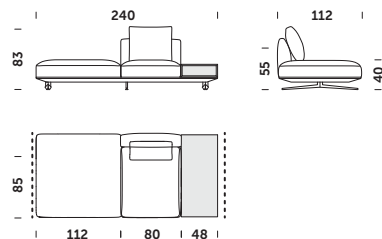

EOP\_256 A  
256x112x83cm

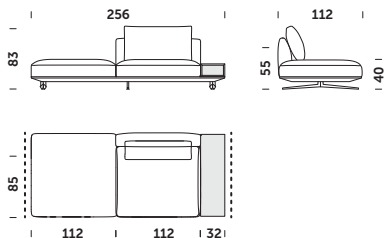

EOP\_256 B  
256x112x83cm

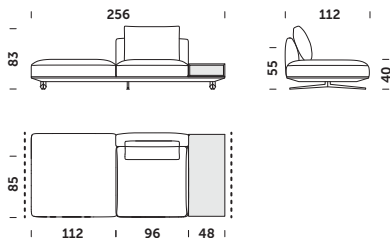

EOP\_272 A  
272x112x83cm

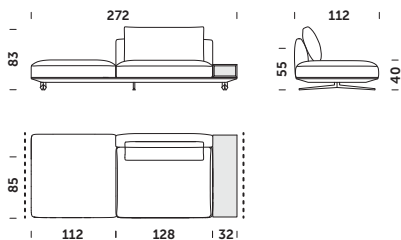

EOP\_272 B  
272x112x83cm

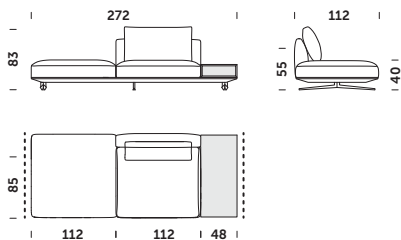

EOS\_112 A  
112x112x83cm

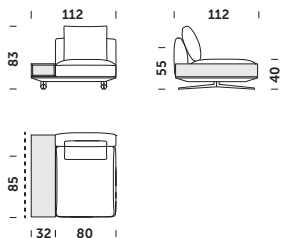

EOS\_128 A  
128x112x83cm

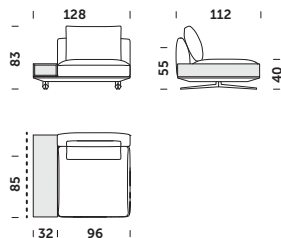

EOS\_128 B  
128x112x83cm

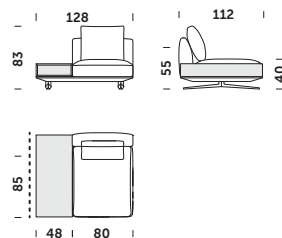

EOS\_144 A  
144x112x83cm

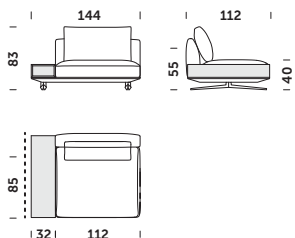

EOS\_144 B  
144x112x83cm

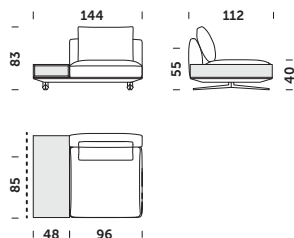

EOS\_160 A  
160x112x83cm

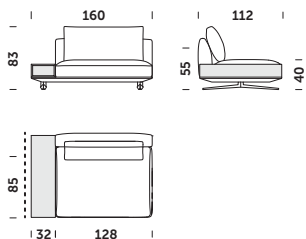

EOS\_160 B  
160x112x83cm

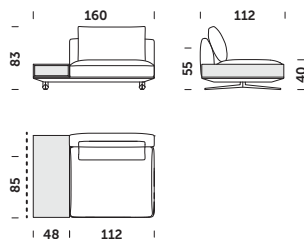

EOS\_176 A  
176x112x83cm

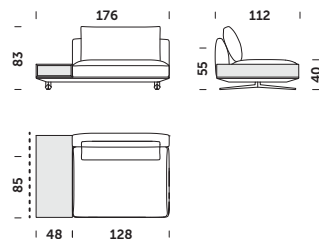

EOS\_192 A  
192x112x83cm

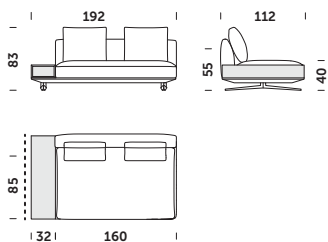

EOS\_208 A  
208x112x83cm

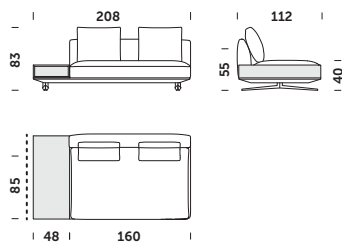

EOS\_224 A  
224x112x83cm

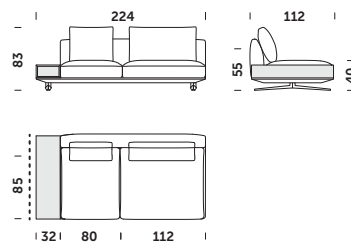

# Grid BOLD *design Jan Kočański, 2022*

EOS\_240 A  
240x112x83cm

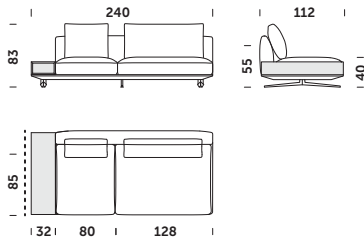

EOS\_240 B  
240x112x83cm

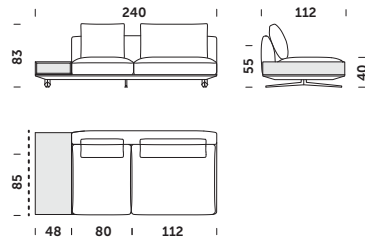

EOS\_256 A  
256x112x83cm

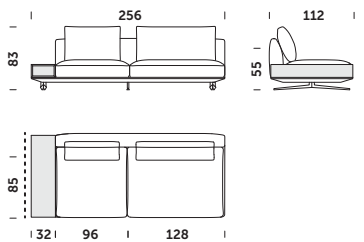

EOS\_256 B  
256x112x83cm

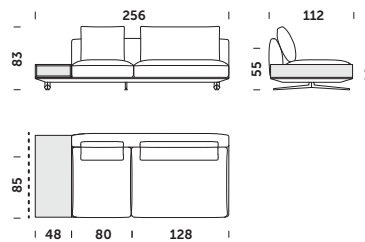

EOS\_272 A  
272x112x83cm

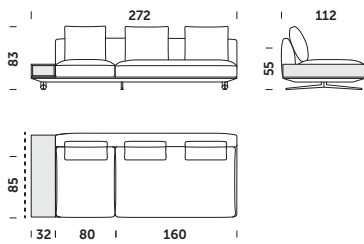

EOS\_272 B  
272x112x83cm

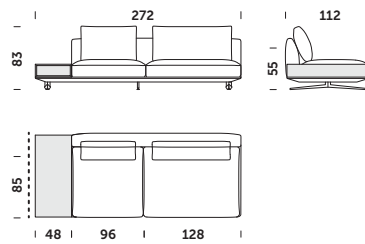

S\_160 A  
160x112x83cm

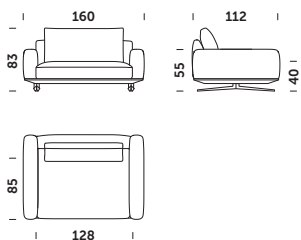

S\_176 A  
176x112x83cm

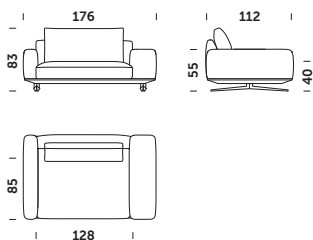

S\_192 A  
192x112x83cm

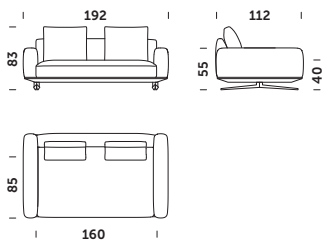

S\_192 B  
192x112x83cm

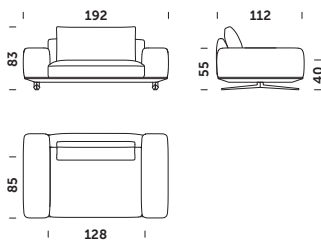

S\_208 A  
208x112x83cm

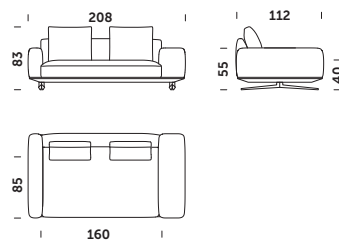

S\_224 A  
224x112x83cm

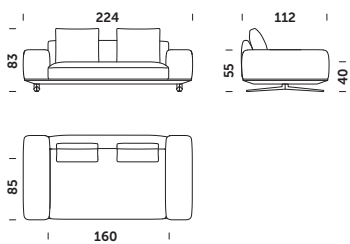

S\_224 B  
224x112x83cm

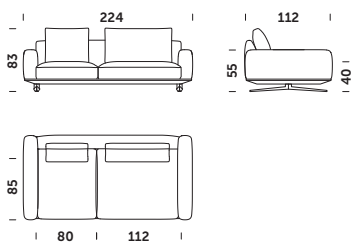

S\_240 A  
240x112x83cm

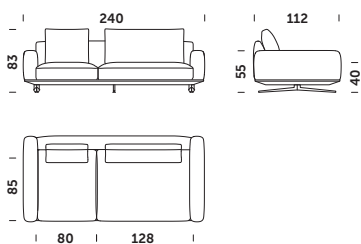

S\_240 B  
240x112x83cm

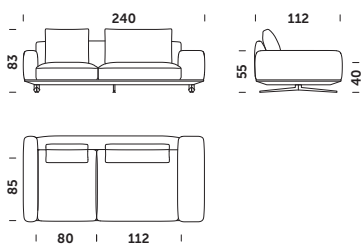

S\_256 A  
256x112x83cm

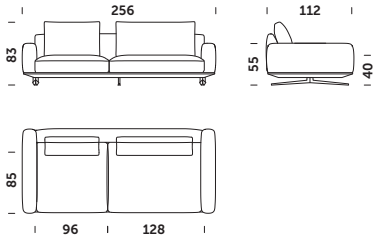

S\_256 B  
256x112x83cm

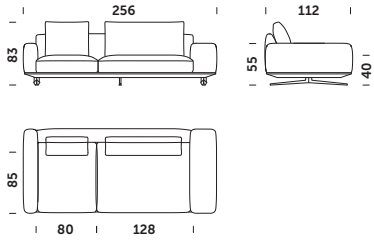

S\_256 C  
256x112x83cm

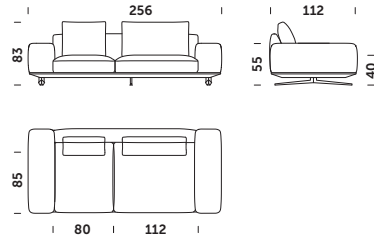

S\_272 A  
272x112x83cm

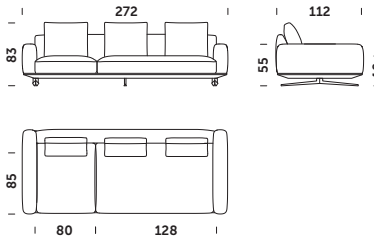

S\_272 B  
272x112x83cm

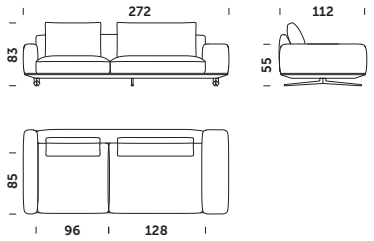

S\_272 C  
272x112x83cm

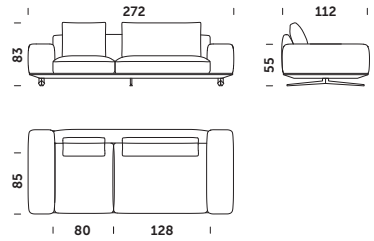

P\_96 A  
96x112x40cm

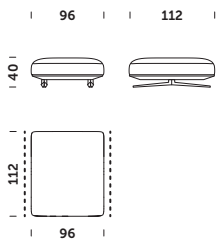

P\_112 A  
112x112x40cm

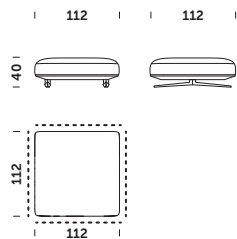

P\_128 A  
128x112x40cm

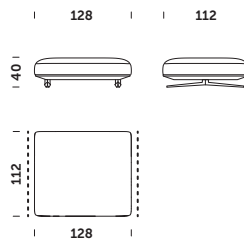

P\_128 B  
128x112x40cm

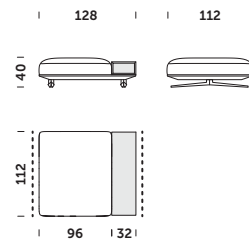

P\_144 A  
144x112x40cm

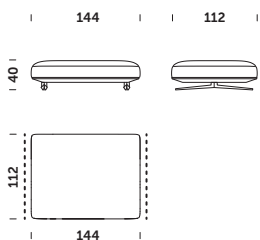

P\_144 B  
144x112x40cm

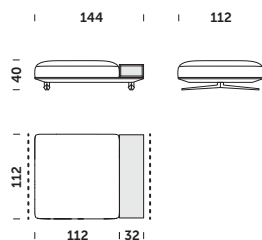

P\_144 C  
144x112x40cm

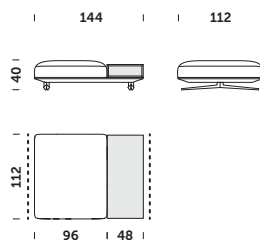

P\_160 A  
160x112x40cm

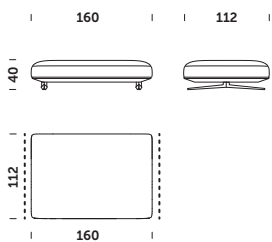

P\_160 B  
160x112x40cm

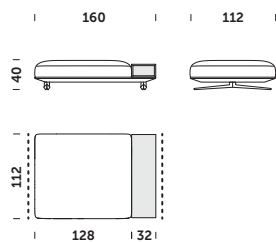

P\_160 C  
160x112x40cm

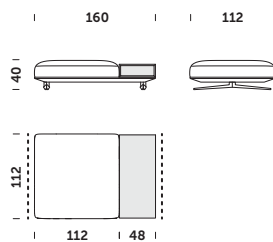

P\_192 A  
192x112x40cm

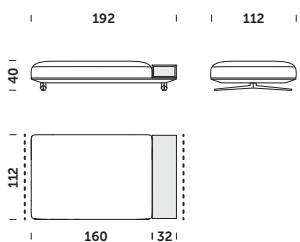

P\_208 A  
208x112x40cm

